



User Manual

High Temperature Series



© 2021 Nyle Dry Kilns
HT Series Manual V4.0



www.nyle.com - kilnsales@nyle.com - (800) 777-6953

Table of Contents

Safety Guidelines	1
Precautions.....	1
Electrical Grounding	1
Your Kiln	2
How your Dehumidification Kiln Works.....	2
Getting Started	2
Floors	2
Ceilings	2
Doors	2
Construction Guidelines.....	3
Baffles and Deflectors.....	3
Unit Installation.....	3
Wet Bulb Installation	4
Dry Bulb Installation	4
Chamber Plans	6
Chamber Dimensions.....	10
Door Gasket Installation	11
Electrical Installation	12
System Test.....	12
Wiring the Leads into the Control Box.....	12
Sensors	14
Sensor Technology.....	14
Dry Bulb Sensor.....	14
Wet Bulb Sensor.....	14
Temperature Limits.....	14
NSC-100 Kiln Controls	14
PLC Modules.....	14
HMI Touch Screen Interface.....	14
Screen Outline	15
Quick Start Guide	16
Menu Bar	16
Status Screen	16
Trend Screen	16
Setup Screen	17
Schedule Screen	17
Schedule Controls	18
Entering a Schedule.....	18
Saving a Schedule.....	18
Loading a Saved Schedule.....	18
Data Logging	18
Starting a Data Log.....	18
Retrieving a Data Log.....	18
Remote Access	18
Password Change & VNC/WEB Remote Access Configuration	18
Setting up Remote Access with VNC Viewer	19
Love Kiln Controls	20
Controller Display	20
Using the Controller	20
Parameters	21

Warning22

Alarms22

Control Wiring22

Drying Lumber.....23

 Loading the Drying Chamber.....23

 Placing Stickers and Loading Lumber.....23

 Insuring Proper Airflow.....23

 Drying Schedules.....23

 Wood Groups24

 Lumber Types24

 Moisture Removal Rates24

 Drying Time24

 Procedures for Drying Softwoods.....24

 Procedures for Drying Softwoods (Depression).....25

 HT-Series Drying Schedules.....25

Drying Schedules.....25

Drying Rates (North American Measure).....38

Drying Rates (Metric).....39

Nyle Drying Chart.....40

 Kiln Sample Boards.....42

 Uses for Sample Boards.....42

 Taking Samples42

 Record Keeping43

 Drying Rate Index (DRI).....43

 Drying Tips44

Spray Systems Kits45

Maintenance46

 General Maintenance for HT-Series.....46

 Suggested Maintenance Schedule.....46

 Air Inlet Filter Maintenance.....46

 Blower System Maintenance.....46

 Lubricating Ball Bearing Motors.....47

 Fan Motor Lubrication Points.....47

 Refrigeration System Information.....47

 Refrigerant Charging Procedure.....48

 Unbalanced 3-Phase Supply Voltage.....50

 System Check Out Procedure.....50

Appendix.....51

 Terminology.....51

The Kiln Store.....52

Warranty.....52

Service Log.....53

Notes.....55

⚠️ WARNING **Read through entire manual before installing, operating, or servicing this unit.** Failure to follow any steps or guidelines could result in personal injury, death, destruction of property or may cause the unit to become inoperable. **This manual must be kept with the unit at all times.**

Safety Guidelines

Precautions

Do not operate if the unit or any of its parts:

- Have been exposed to fire.
- Have been submerged in or exposed to excessive water.
- Has significant interior or exterior damage.

If any of the above are suspected make sure to have your unit serviced by a qualified professional before continuing operation.

Electrical Grounding

The unit must be grounded.

Failure to ground the unit will result in unreliable performance or an inoperative unit. You can ground the unit by connecting the unit to a grounded metal, permanent wiring system. Make sure the unit is in accordance with national and local electrical codes. If you don't know the building codes in your area or need more information, please contact your municipal office.

⚠️ WARNING	Refrigerant!
<ul style="list-style-type: none">• Unit contains R-416a / FR12 refrigerant under high pressure. Refrigerant must be recovered to relive pressure before servicing.• DO NOT use unapproved refrigerants, substitutes or additives.• Failure to abide by these guidelines can result in death, injury and property damages.• Contact Nyle's service department for more information on refrigerant options.	

⚠️ WARNING	
High Temperatures!	
<ul style="list-style-type: none">• Kiln chamber can reach internal temperatures of over 90°F. working in these temperatures can cause heat stroke and minor burns.• Pregnant women, children, the elderly and those with significant health issues are at higher risk of heat stroke and must be supervised in high temperatures.• Kiln operators should check for temperature and take proper safety precautions before entering the kiln chamber.	

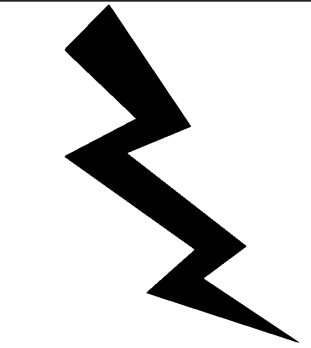
⚠️ WARNING	
Electrical Shock!	
<ul style="list-style-type: none">• Turn off power to unit before service.• Make sure wires are labeled before disconnecting.• Test unit after reconnecting wires.• Failure to do the above could result in death or injury.	

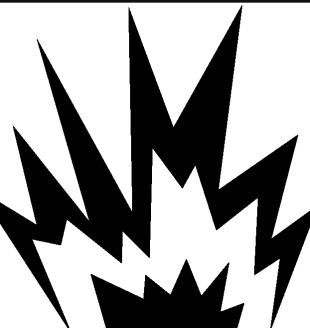
⚠️ WARNING	
Explosion Hazard!	
<ul style="list-style-type: none">• DO NOT purge or pressurize this system with oxygen to test for leakage. Using oxygen may cause explosive reaction.	

Your Kiln

How your Dehumidification Kiln Works

Thank you for purchasing a Nyle Dehumidification Kiln and taking the first step towards making the lumber industry cleaner and more efficient! Years of development, innovation and the highest quality materials have gone into building your kiln. It's our dedication to efficiency that sets Nyle System kilns apart from the rest and makes your system the best on the market.

During kiln drying, moisture from green lumber is evaporated into the air increasing the humidity inside the chamber. The moisture must be periodically removed from the chamber because the lumber can't continue to dry if the air becomes over-saturated. In a conventional kiln moisture would be expelled through venting. Venting causes a significant loss of heat resulting in a waste of energy to bring the kiln back up to temperature.

Nyle Dehumidification Kilns don't waste energy through venting. Instead a refrigeration system condenses the excess moisture and is drained off retaining the existing heat energy to be reused. After the moisture is removed and heat is reintroduced to the dry air it is pumped back into the kiln chamber to start the process over. Unlike conventional kilns the heater in your Nyle Kiln is only used during the initial warm up and sometimes when temperature increases are desired during the cycle, saving you time and money. But that's not all your new kiln has to offer!

Though Nyle kilns don't rely on venting to get rid of moisture, a Vent System is supplied to add extra control of your kiln temperature. If the internal kiln temperature exceeds what's required, these vents can be opened to remove excess heat and bring the temperature back to where it needs to be.

Finally Nyle Systems offers a wide variety of upgrades and accessories to enhance your kiln drying experience. See the upgrades and accessories section for more information, or visit the kiln store on our website at www.nyle.com. By purchasing a Nyle Kiln you have the support of Nyle's service team, the very same professionals that built and tested your unit. Enjoy your new system!

Getting Started

Please read through carefully as some options may not apply.

Floors

Concrete floors with insulation installed underneath is recommended for best results. However if the kiln is going to be on an existing concrete floor, the insulation may be omitted. Concrete must not extend beyond the kiln walls.

Wood floors may be used but must be built to construction guidelines (see Pg 3)

Ceilings

If the kiln chamber is a freestanding outside building, the attic space must be well ventilated through the eaves. This is done to avoid any moisture buildup in this space, which will condense on the cold roof and drip onto the insulation.

An interior kiln can have the ceiling insulation open to the atmosphere.

Ceilings must be built to construction guidelines. (Pg 3)

Doors

At the front of the kiln chamber install bay/loading doors with at least two sides hinges and a center door latch to close (recommended). Top hinged or a lift off doors are also acceptable.

At least one access door should be installed in the back of the chamber to allow for service of the dehumidifier and/or lumber monitoring.

All installed doors must:

- Be built to construction guidelines. However they may be lightened by increasing the stud spacing and using 3/8" plywood. The lighter weight will reduce the load on the hinges
- Have a vapor barrier.
- Have gaskets wherever the door meets the kiln; this will give a good, airtight fit.
- Have a scraper type weather strip to reduce air leakage if door sill is not present.
- Close tightly against the gasket using turnbuckles, tarp straps, lag studs with wing nut, etc.

Remember: There will be considerable expansion and contraction during kiln use so it is imperative to plan your kiln door construction accordingly.

While outside electronic moisture meters can be used to avoid entering the kiln, during the drying cycle, Nyle strongly recommends regular checks inside the kiln to visually inspect the surface or ends for checks, mold, stain as well as testing with a hand held meter.

Construction Guidelines

Please reference Chamber Plans on pages 6-10 for more information on construction.

Step 1: Build all walls, ceilings and floors with a 2" x 4" framework using blue or pink Styrofoam (extruded polystyrene) friction fitted between the studs.

Step 2: Cover the interior face of the studs with a 1" layer of Celotex Thermax (or for better results overlap two ½" layers).

Celotex Thermax is foil faced polyisocyanurate (urethane) board which is orange or yellow in color and is available in 4' x 8' sheets of various thicknesses. Celotex Thermax is a trade name, similar products under other trade names are acceptable.

If you want to use spray foam insulation, only use urethane based spray foam applied at 2.2lb/cu ft. Fiberglass is never recommended.

Step 3: Caulk joints and nail heads with a high temperature silicone (optional: apply aluminum tape over silicone)

Step 4: Cover Thermax with one or two layers of 6 mil polyethylene, then enclose with ½" CDX or marine grade plywood.

Step 5: Coat CDX interior surface with "mobile home or metal roofing aluminum paint"

Paint is an asphalt based coating with powdered aluminum and fiber for strength, available in most hardware stores. Re-coat as necessary every year.

Step 6: Finish exterior walls to suit your tastes, but avoid galvanized steel or other ferrous sidings.

Baffles and Deflectors

Do not underestimate the effect of baffling. Correct baffling will result in faster and more even drying. The benefits more than offset the extra time and effort to correctly place the baffles.

- **Corner deflector:** typically made of plywood are used to help turn the airflow.

- **Top Baffle:** Hinged baffle that falls from the fan wall to the top of the load used to compensate for different load sizes, and allow for shrinkage of the board pile.
- **Side Baffle:** Baffle that closes in the open space when lumber that does not fill the entire width. This baffle can be fixed or portable.
- Baffles between the lumber packages where the load supports are placed.

Note: A 28' wide kiln, loaded 4 packages high using 4"x4" load supports has the open space equivalent to a 5'x7' hole. Approx. 7/8 of the capacity of 1-3 HP circulation fan is wasted pushing the air through this bypass opening.

Unit Installation

Please reference Chamber Plans on pages 6-10 for more information on installation.

1. Position the Dehumidification Unit in the opening between the control room and the kiln chamber. Be sure that both side service panels will be removable from inside the chamber.
2. Elevate the unit to help accommodate drain piping (8" is usually enough).
3. Choose one of the two drains provided and pitch the unit towards the one you choose. Be sure to plug the unused drain.

Note: The drain that will be used must be equipped with a "P" type trap to prevent air from being drawn up the drain and holding water in the pan. Using CPVC is fine for this application.

4. Seal the opening around the unit from the kiln side of the wall using weather stripping or silicone sealant.

Note: To avoid issues with moisture, make sure to properly seal the entire opening even under the unit.

5. Install the vents from the outside with the actuator on the outside of the kiln chamber. Position the vents diagonal from one another with one in the front of the chamber and the other in the rear. This is done to allow fresh air to mix with kiln air encouraging even temperature throughout.
6. Wire the vents back to the dehumidifiers electric panel and connect to TB1 terminals T1 & T2.
7. Install the weather shield over the actuator. (The weather shield is shipped inside the vent.)

Note: The circulating fans housing, motor, and direct drive blade can be assembled before installation. Nyle recommends installing the housing before the motors are mounted.



8. Mount fans over the lumber pile in the boxed beam fan truss spacing them evenly with the motors facing the rear plenum side. Any spaces between the fans must be blocked off to prevent air short-cycling.
9. Mount the fan motors using the stainless steel hardware provided (5/16 x 1 1/4 bolt, two 5/16 flat washers, one 5/16 lock washer, and one 5/16 nut).
10. Attach the steel fan blades using a taper lock bushing as close to the venturi ring as possible, leaving a tip clearance of approximately 3/16". Tighten the taper lock bushing to 90 inch-pounds. **DO NOT over tighten.**
11. Spin each fan by hand checking for blade warping, and that the tip clearance does not change. This type of fan performs best with a very small tip clearance.
12. Wire each fan to the individual overloads within the electrical panel.
13. Mount the electric heat duck stack to the dehumidification unit. Fasten at the corners using the provided self drilling self tapping tek screws.

Wet Bulb Installation

1. The wet bulb is mounted on a bracket. Mount the bracket on the wall near the dehumidifier, roughly 4 feet (1.2m) off the floor, so that it is receiving proper air flow.
2. Push the sensor through the hole in the fastener leaving roughly 1/2" of the sensor on the other side.
3. Gently tighten the fastener to hold it in place. **DO NOT over tighten the fastener as it can cause damage to the sensor**
4. Put the wick material into the bottle, and loop through the opening .
5. Slide 2" (50mm) of the material onto the sensor.
6. Store replacement water (covered) inside the kiln so the wet bulb temperature readings are not as effected by refilling.

WARNING: The wick surrounding the wet bulb sensor must be maintained always wet. The wet bulb sensor cannot be in the water and must be positioned close to the dry bulb, in a position in the air flow. If these conditions are not satisfied, the control could regulate the kiln for a too dry setting, damaging the wood to be dried.

Dry Bulb Installation

HT-Series Systems have a reverse fan system that requires the installation of two Dry Bulb sensors, one front dry bulb (FD) and one rear dry bulb (RD) with provided 6" long aluminum sensor brackets.

Note: If you do not have this system you will only be required to mount one Dry Bulb sensor.

1. Using the dry bulb sensor bracket mount the FD sensor high on the ceiling or wall of the front plenum, near the loading door.
2. Push the sensor through the hole in the fastener leaving roughly 1/2" of the sensor on the other side.
3. Gently tighten the fastener to hold the sensor in place at a slight upward angle. **DO NOT over tighten the fastener as it can cause damage to the sensor.**
4. Slide the thermal lag (1" piece of aluminum with a hole on one end) over the end of the sensor. The thermal lag functions as a buffer for the temperature sensor for more accurate temperature readings preventing the system from short-cycling.
Note: If the Thermal lag feels like it might fall off you may need to increase the upward angle of the sensor.
5. Gently coil and fasten any excess lead wire out of the way. **DO NOT cut, staple or puncture through the lead wire.**
Note: The excess lead wire provides mobility in case the DB needs to be relocated to get better readings.
6. Mount the RD sensor in the rear plenum of the kiln chamber near the wet bulb sensor. Repeat steps 2-5 to finish installing the RD.

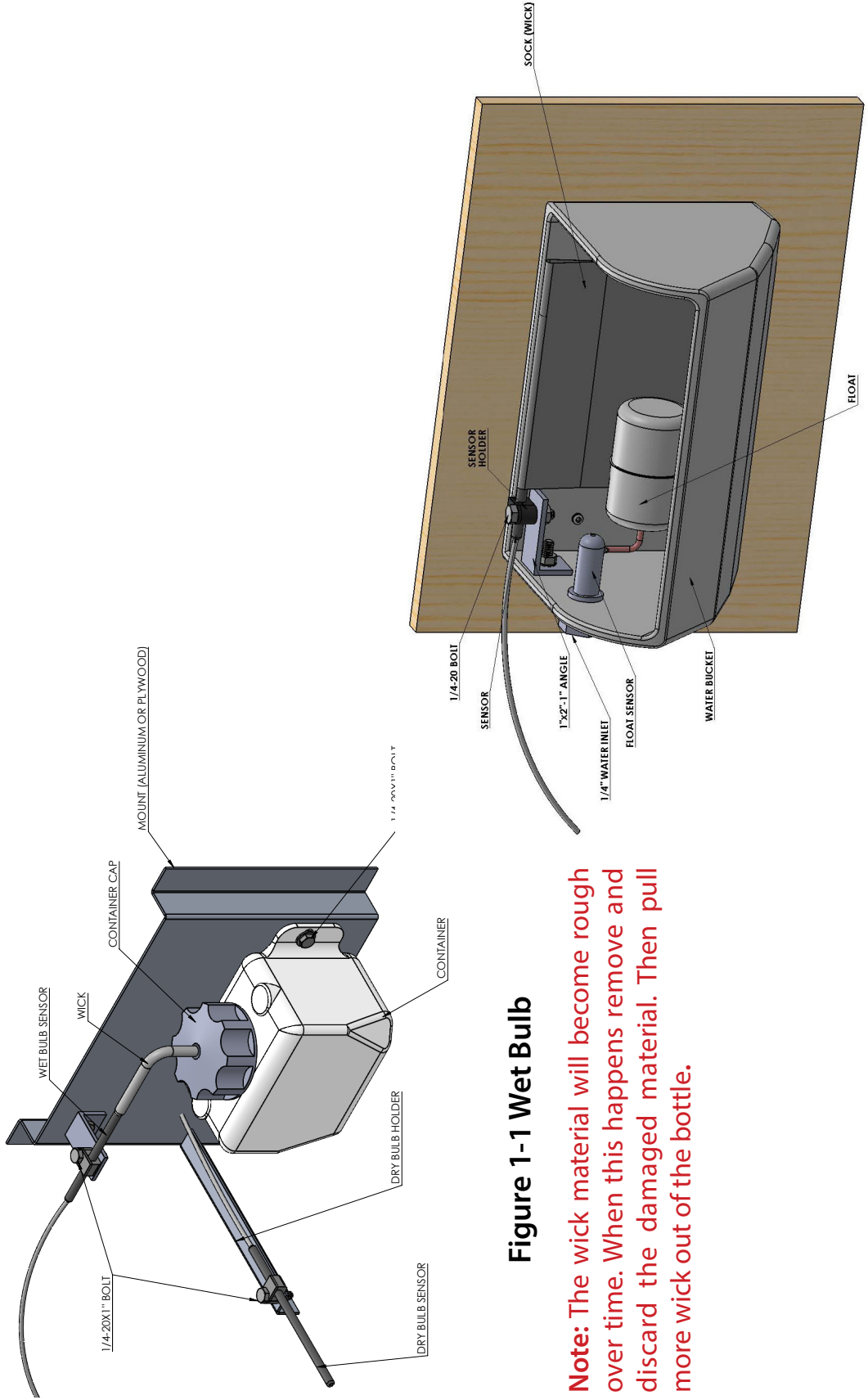
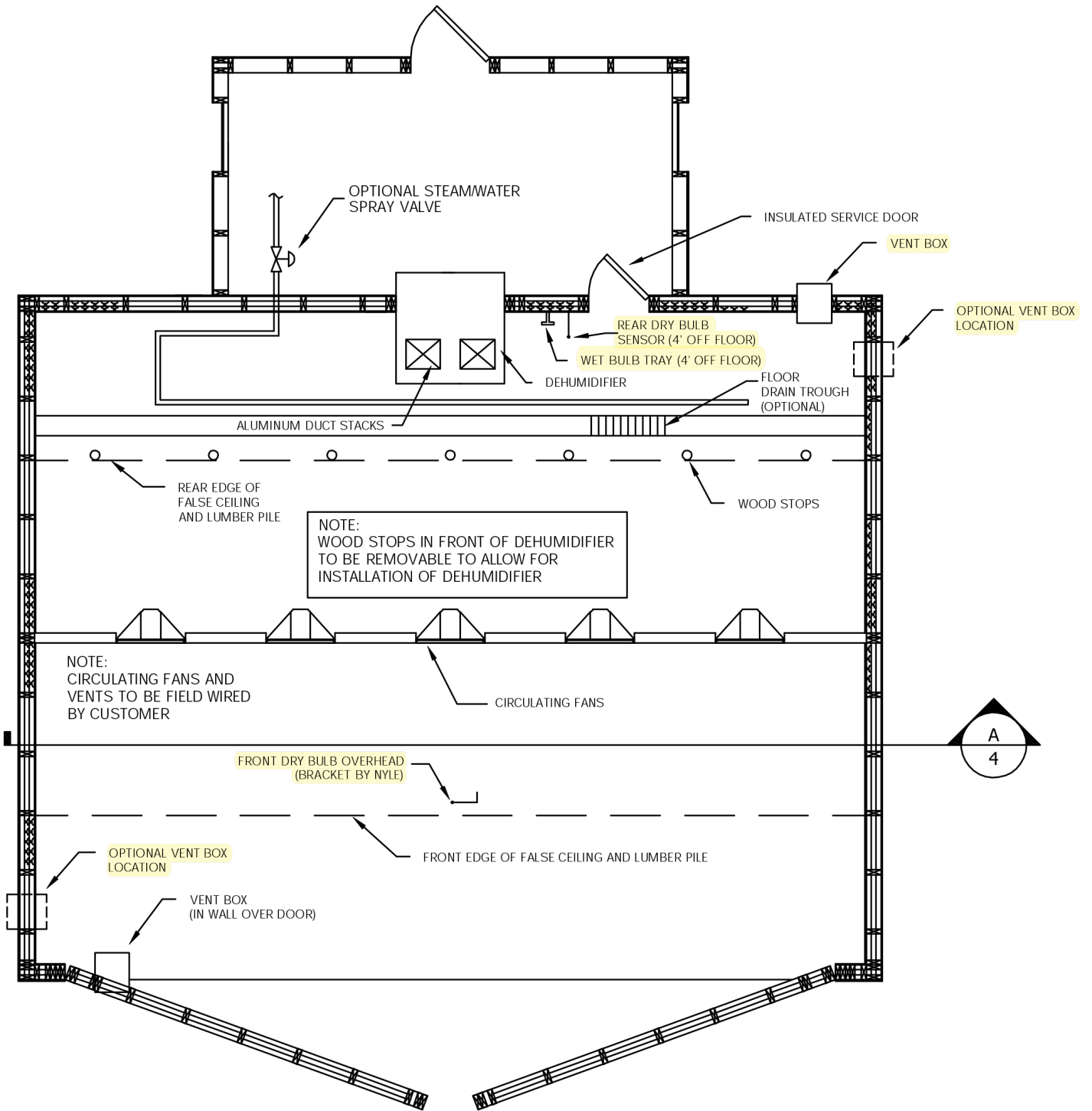
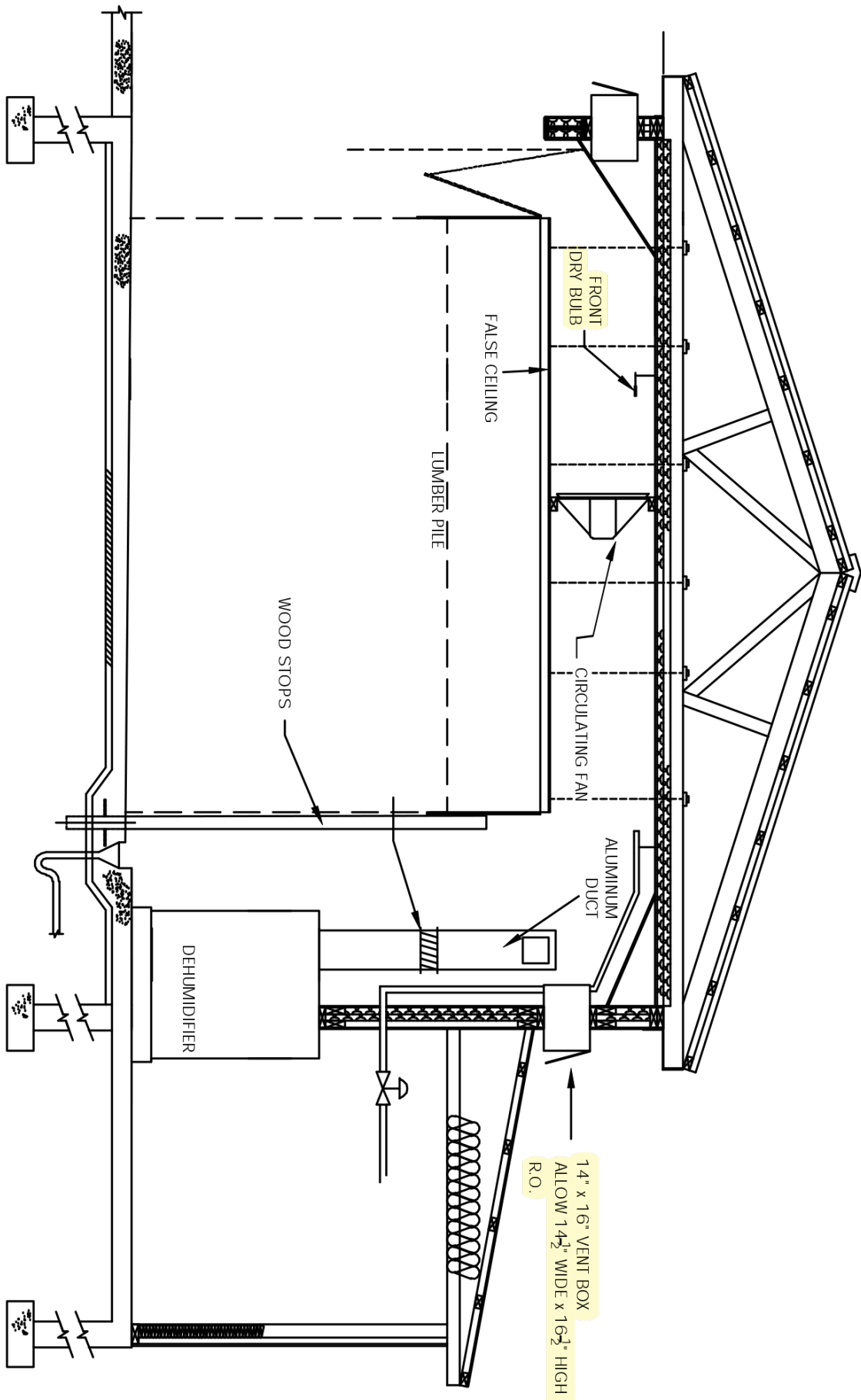

Figure 1-1 Wet Bulb

Note: The wick material will become rough over time. When this happens remove and discard the damaged material. Then pull more wick out of the bottle.

Do It Yourself Chamber Plans





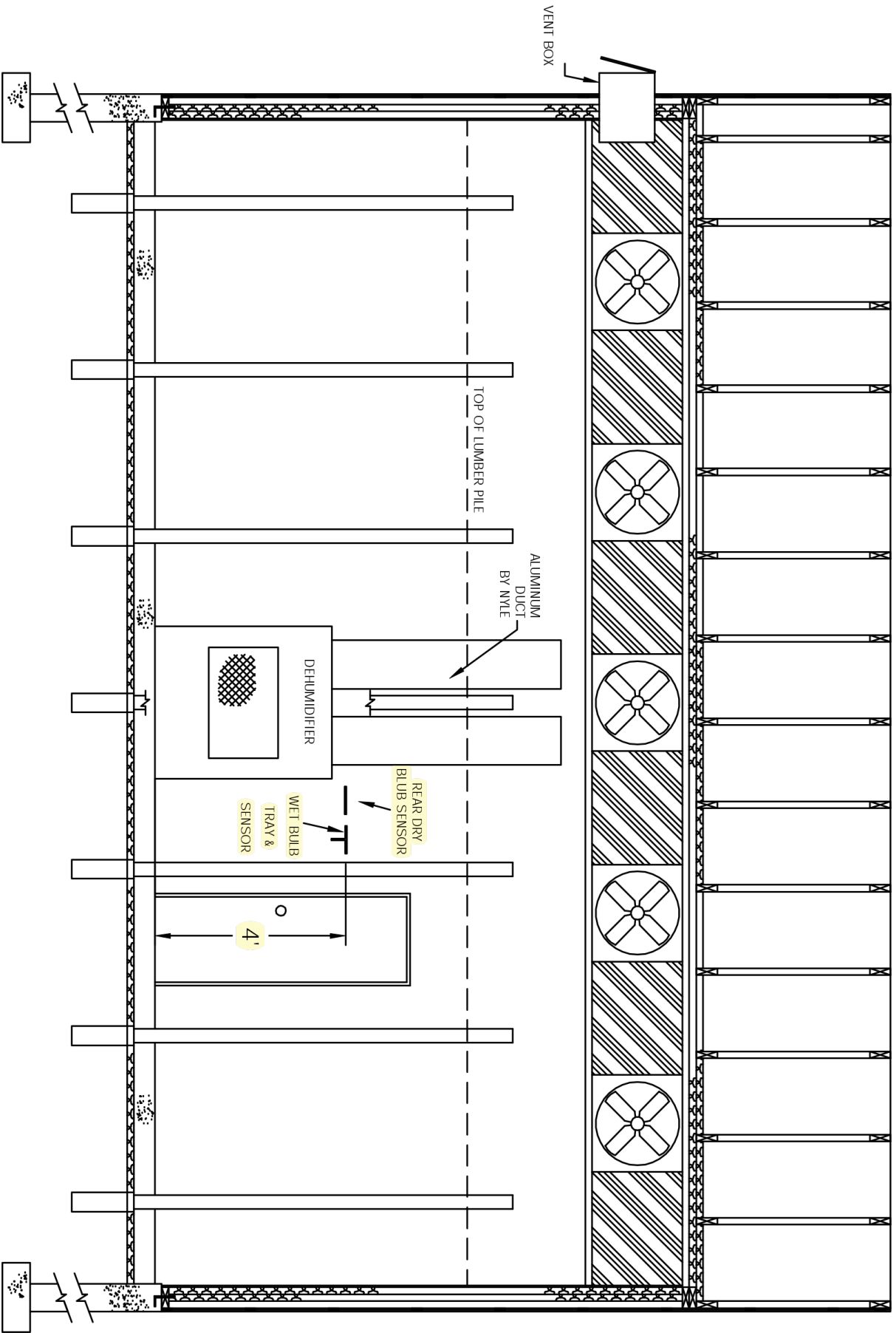

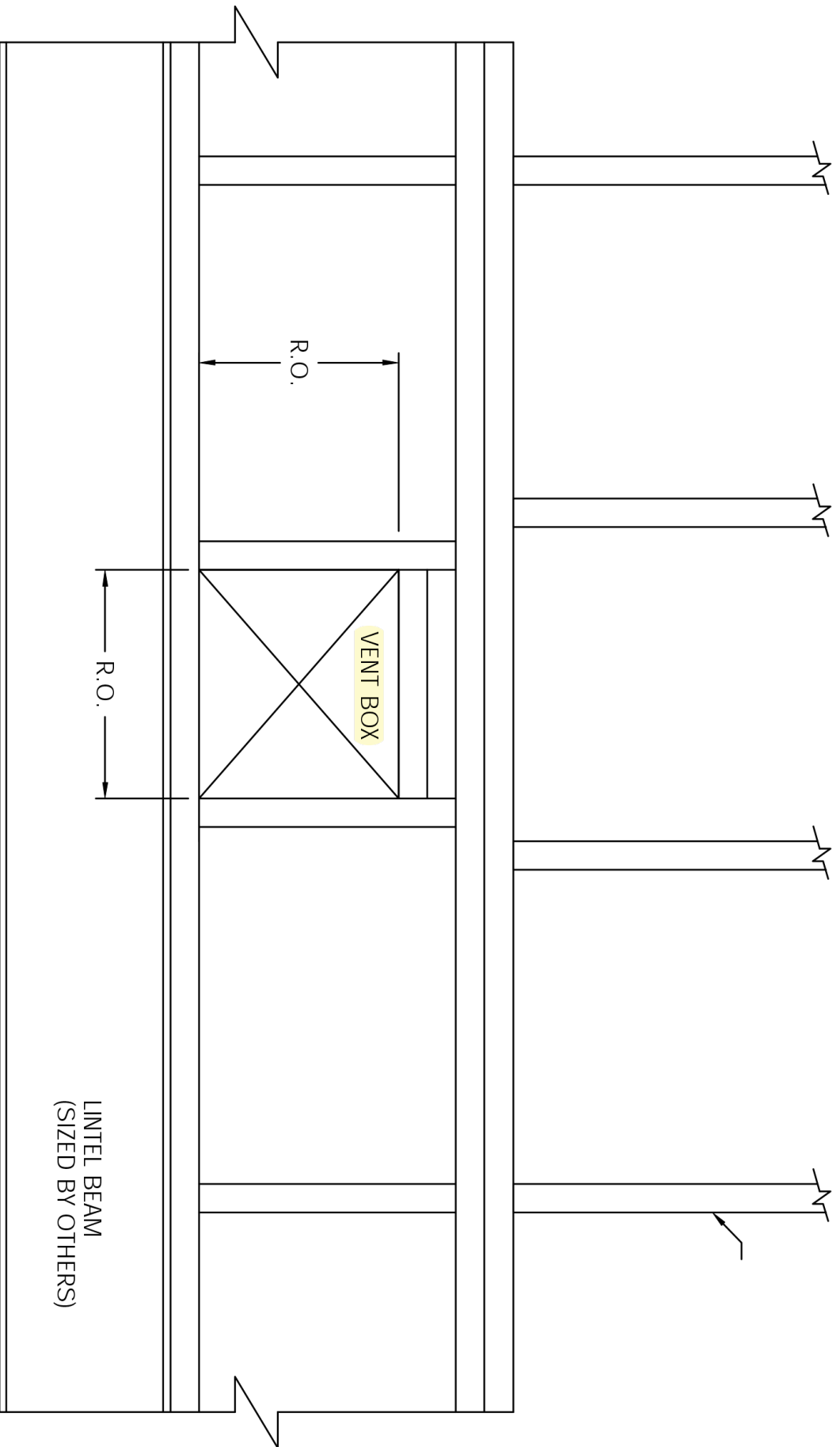

NOTE:
 FRAMING SHOWN IS FOR WALL OVER DOOR
 WITH CLEARANCE THROUGH FIXED DEFLECTOR.
 THE VENT BOX ROUGH OPENING WILL BE THE
 SAME FOR THE REAR VENT.

Chamber Dimensions

L300 & L500 CHAMBER DIMENSIONS

BF OF LUMBER	NET LENGTH (ft.)	STICKER SIZE (ft.)	PKGS. DEEP	# OF 4" BOLSTERS	# OF LAYERS	BUILDING DIMENSIONS (OPEN SPACE INSIDE) (ft.)						
						A	B	C	D	E	F	G
4800	16	4	2	2	44	19	16	9	12	17	8	8
	16	4	2	3	55	19	16	11	14	17	8	10
	24	4	2	2	37	27	16	8	11	25	8	6
6000	16	3.5	3	2	42	19	19	9	12	17	11	7
	16	3	4	2	37	19	20	8	11	17	12	7
	24	4	2	2	49	27	16	10	13	25	8	8.5
8000	16	4	2	3	74	19	16	14	17	17	8	12.5
	16	3.5	3	3	56	19	19	11	14	17	11	10
	16	3	4	2	49	19	20	10.5	13.5	17	12	9
10000	16	4	4	2	46	19	24	9	12	17	16	8
	24	4	3	2	41	27	20	9	12	25	12	7.5
	24	4	3	2	49	27	20	10	13	25	12	8.5
15000	24	4	3	3	61	27	20	12	15	25	12	10.5

L1200 CHAMBER DIMENSIONS

BF OF LUMBER	NET LENGTH (ft.)	STICKER SIZE (ft.)	PKGS. DEEP	# OF 4" BOLSTERS	# OF LAYERS	BUILDING DIMENSIONS (OPEN SPACE INSIDE) (ft.)						
						A	B	C	D	E	F	G
10000	18	4	3	3	54	22	24	11	15	19	12	10
13000	18	4	4	4	53	21	24	11	14	19	16	10
15000	25	4	3	2	59	28	20	11.5	14	26	12	10
20000	25	4	3	3	78	28	20	15	17	26	12	13
22000	25	4	4	3	65	28	24	13	15	26	16	11
25000	25	4	4	3	74	28	24	14	17	26	16	13
30000	25	4	4	4	88	28	24	17	19	26	16	15
35000	25	4	4	4	103	28	24	19	22	26	16	18

- A - BUILDING WIDTH
- B - BUILDING DEPTH
- C - DOOR HEIGHT
- D - EAVE HEIGHT
- E - DOOR WIDTH
- F - LUMBER DEPTH
- G - LUMBER HEIGHT
- H - UNIT HEIGHT
- I - UNIT WIDTH
- J - UNIT DEPTH
- K - DISTANCE UNIT EXTENDS INTO CHAMBER

UNIT	UNIT DIMENSIONS (in.)			
	H	I	J	K
L300	51	44	45	29
L500	51	44	45	29
L1200	54	64	66	39

ROUGH OPENING FOR UNIT
SHALL HAVE A 1" CLEARANCE
AROUND UNIT.

1 KILN CHAMBER SIZE CHART

DRAWINGS ARE SUGGESTIONS ONLY. VERIFY DESIGN AND ENGINEERING LOCALLY. NYLE PROVIDES THESE DRAWINGS AT NO CHARGE AND TAKES NO RESPONSIBILITY FOR THEIR USE.



18 Stevens Road
Brockton, MA 01942
Tel: 1-807-989-4335 Int'l: 1-800-777-6953
Fax: 1-807-989-101 Email: info@nyle.com

DRAWN BY	REF	DATE	12-29-16
CHECKED	DATE	SCALE	
		SHEET	16 OF 16
		REV	00
		DWG NO.	

Door Gasket Installation

GASKETS AND DOOR KITS AVAILABLE FROM NYLE

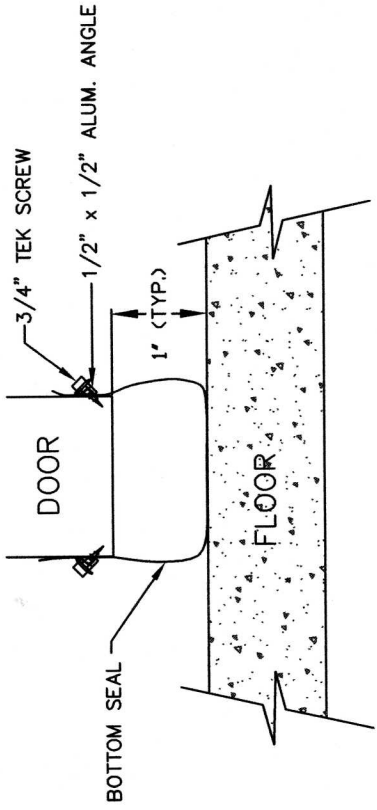

INSTALLATION OF BOTTOM DOOR GASKET

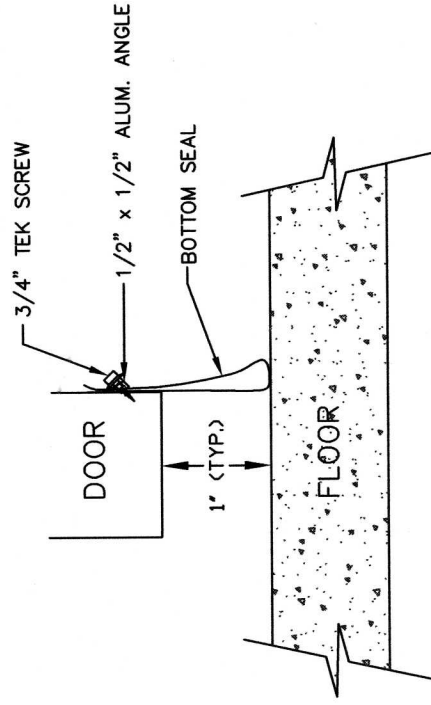

ALTERNATE INSTALLATION OF
BOTTOM DOOR GASKET

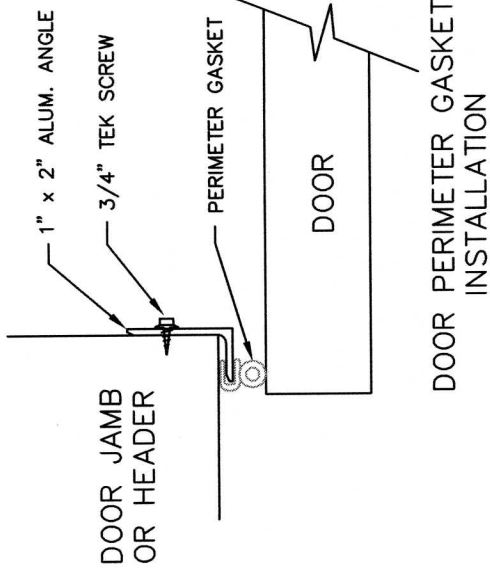

DOOR PERIMETER GASKET
INSTALLATION

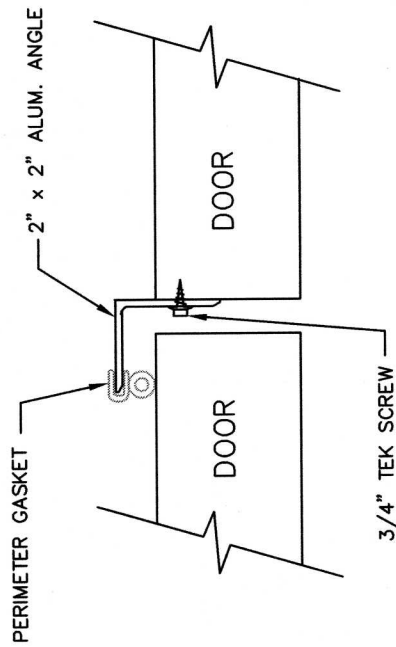

INSTALLATION OF CENTER DOOR GASKET

ADJUST ANGLE INSTALLATION SO THAT
GASKET IS SLIGHTLY COMPRESSED

Electrical Installation

1. Bring power supply to main distribution block in upper right corner of Nyle unit electric panel. The electric panel is on the same side as the control room. Refer to the data plate on the unit for wire sizing amps and maximum fuse size.
2. Run a separate circuit from the electric panel in the unit to each circulating fan in the kiln. (The number of fans will be shown on the nameplate.) The power supply to each fan is connected to the appropriate motor overload protectors in the main panel.

If the wire is run in conduit, only use aluminum conduit and seal the inside of the conduit where the it passes through the kiln wall from the control room to prevent condensation from forming inside the conduit. **Do not use PVC or galvanized conduit or hangers inside the kiln chamber.**
3. Run a separate 18/2 circuit to each vent. Connect the vents to terminals T1 and T2 on the vent terminal strip. Standard vents (not equipped with exhaust fans) are 24v.
4. The wires and the safety switches inside the electric heat duct are factory assembled and tagged to indicate which terminals they correspond to. Double check that they are properly connected.
5. Connect the power cord at the bottom of the heat duct electrical panel to the corresponding plug on the unit cabinet.
6. Connect the main power source to the unit with the customer supplied master disconnect. **Make sure all selector switches (system, refrigeration, exhaust, and heat) are turned off.**

System Test

During the system test if any equipment appears to be functioning incorrectly DO NOT move to the next step. Turn off the selector switches, de-energize the unit and check the installation before moving on.

1. Energize the main power connection to the unit.

2. Turn on only the System switch. This will start the internal blower, and the controllers will display the kiln conditions.
3. Turn the FAN switch to FWD, to start the circulation fans.
4. Check that all the fans are turning in the same direction, with the wind blowing toward the front loading door.
5. Remove the front access panel (over the inlet air filter) to check the blower rotation. The blower wheel should accelerate the air around the housing and blow it up and out.

Note: If either the blower or the fans are turning the wrong way, turn the master disconnect 'OFF', then reverse any two power leads (three phase units only) to correct the rotation. Do not be concerned with the rotation of the compressor, as it is designed to turn either way.
6. Turn off the blower to check that the blower components are properly greased and everything is tight. **Components may loosen up during shipment.**
7. Remove the thermal lag from the front dry bulb sensor and place a cold wet rag over it. This should result in a temperature drop on the kiln controller. If the temperature does not change after a few moments, the sensor may be reversed.
8. Repeat step 7 for the rear dry bulb.

Note: After the first load has been dried go back and check the blower belt tension. New belts will stretch after first use.

Wiring the Leads into the Control Box

To connect the system to the control box, first find the main control module in the electrical/control box inside the control room:

If you open the electrical/control panel in the control room and look for the main control module, you will find a gray plastic box that looks like this.



If there is a plastic insert where the above picture is labeled TxD and RxD, interfacing with the probe packages should be as simple as replacing the plastic insert with the provided snap-in module, and wiring the leads from the kiln into the snap in module, like this: Black to M, white to T/RA, white jumper between TA and T/RA, green to T/RB, and a green jumper between T/RB and TB.

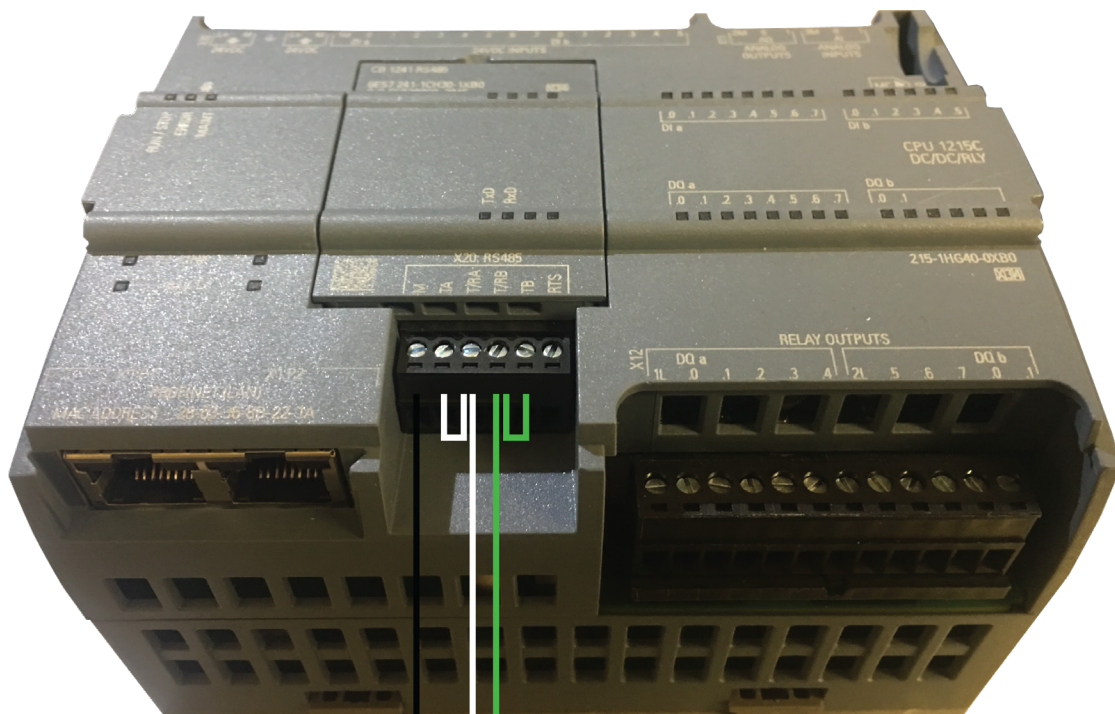

Sensors

Sensor Technology

Every Nyle Dehumidification Dry Kiln System measures and regulates internal kiln conditions through the use of Dry Bulb and Wet Bulb Sensor Technology. Each of these sensors measure different temperatures inside the kiln chamber and regulate various system functions. They provide information about the kilns internal conditions used to determine relative humidity (RH) and estimated moisture content (EMC). The two sensors are installed within the kiln chamber and are connected to the kilns controller where the information they collect can be managed and utilized by the kiln operator, and stored for later reference.

Dry Bulb Sensor

This sensor measures the dry bulb temperature (DBT). The DBT measurement given by the sensor is the true thermodynamic temperature inside the kiln. You can set the desired DBT from the kiln controller. This setting will control the kilns exhaust vents and heat, which will be automatically adjusted to accommodate the desired DBT.

Example: If the DBT falls below the set parameter the system will turn on the heat. Or if the DBT rises above the set parameter then the system will open the vents.

If your DBT is rapidly fluctuating a thermal lag may be added to the sensor to help stabilize readings, contact Nyle for information on how to install one if necessary.

Wet Bulb Sensor

This sensor measures the wet bulb temperature (WBT). The sensor is equipped with a water wick that is cooled through evaporation bringing its temperature reading below that of the dry bulb. This lower temperature is the WBT, the lowest temperature that can be reached inside of the kiln, through the evaporation of water, under the current ambient conditions. You can set the desired WBT from the kiln controller as well. This setting controls the kiln compressor and spray system which will be automatically adjusted to accommodate the desired WBT.

Example: If the WBT falls below the set parameter the system will turn on the spray system. Or if the WBT rises above the set parameter the system will turn on the compressor.

Temperature Limits

The wet bulb should not be allowed to exceed 120° F (50° C) in operation.

Even if the WB is set below 120° F it can still exceed this temperature. To correct this lower the DB setting by the number of degrees over 120° F the WB temperature has gone.

Example: If you have your WB set to 118° F but it is operating at a temp of 124° F. You will lower your DB temp by 4° F to drop your WB temp at or below 120° F.

The dry bulb should never be set above 160° F (71° C) unless the compressor is turned off.

The compressor should not be turned on unless the dry bulb is over 85° F (29° C). wet bulb is over 75° F (24° C).

NSC-100 Kiln Controls

PLC Modules

The NSC100 advanced control system uses a Siemens-based S7-1200 PLC controller with a built-in Ethernet switch, 24VDC power supply, and RTD-based temperature module.

HMI Touch Screen Interface

The NSC100 uses a 7" color touch screen control as the main interface for operating the kiln chamber. The HMI touch screen is capable of performing all kiln operations including managing schedules, creating and storing data logs, displaying trends of the current cycle, setting kiln mode types, monitoring status, and more.

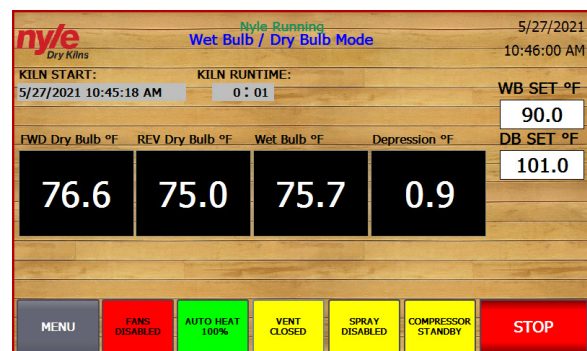

Status Screen

Screen Outline

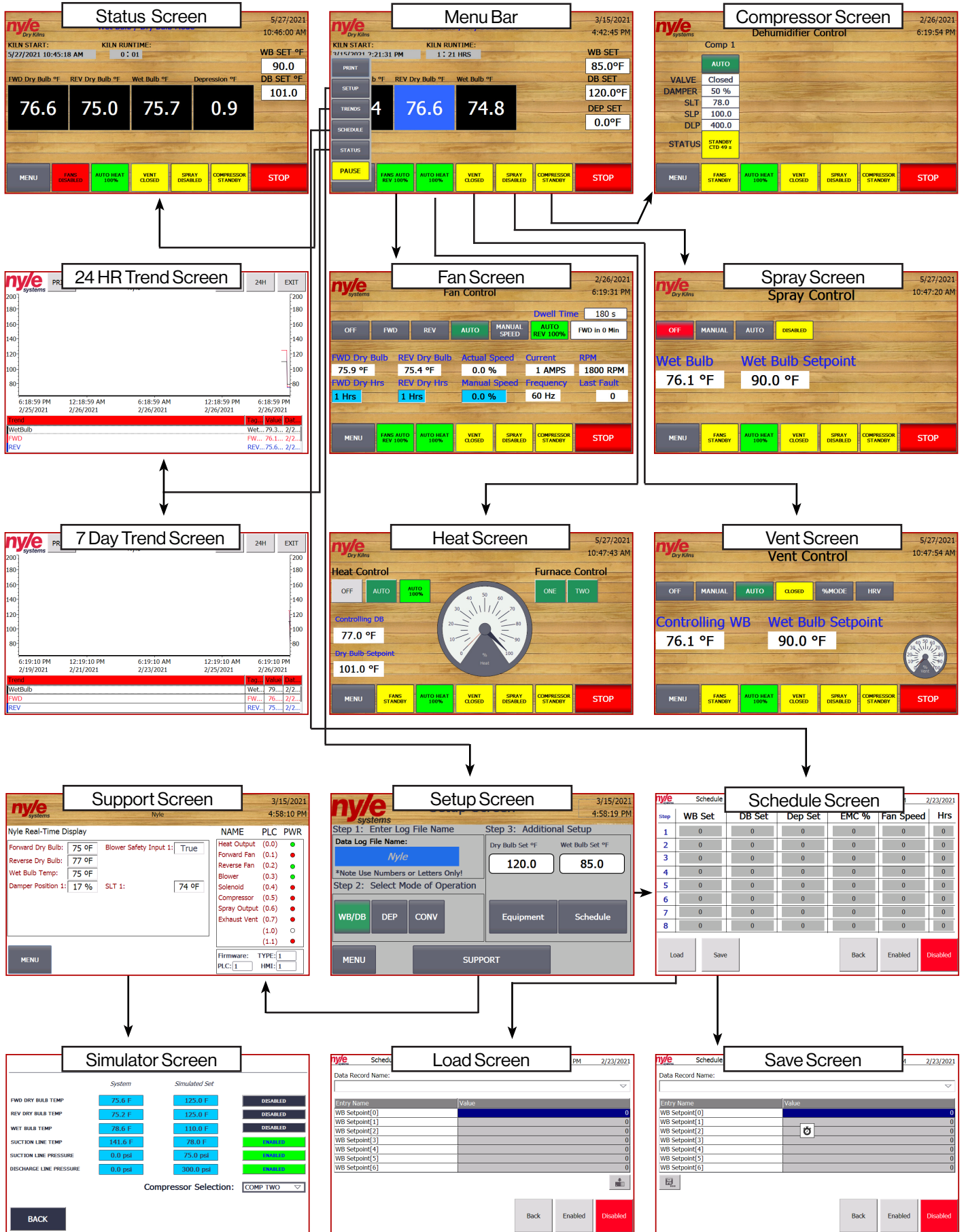

Quick Start Guide

Menu Bar

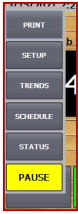

From the menu bar, the user can navigate to 3 function screens; status screen, trend screen and setup screen.

Function Buttons:



The "Menu" button will toggle the function buttons to access the function screens



The "Print" button allows you to print the screen you are on. **Note: a printer must be installed and configured to your control in order for this feature to work.**



The "Setup" button will bring you to the setup screen where you can enter the log file name, kiln mode as well as navigate further to the schedule and support screens.



The "Trend" button will bring you to the trend screen where you can see the graphs of the kiln cycle.

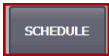

The "Schedule" button will bring you to the schedule screen where you can see and edit the kiln's schedule.

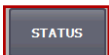

The "Status" button will bring you to the status screen where you can see the status of the kiln cycle.

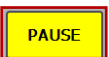

The "Pause" button allows you to pause the kiln cycle at any point and be able to resume from where you left off.

Equipment Buttons:



The user can also access the five equipment screens along the bottom. These screens are the fan, heat, vent, spray and compressor. These buttons will take the user to the corresponding screens but also display their current conditions

Status Screen

From the status screen, the user can see all of the real time kiln conditions during the drying cycle.

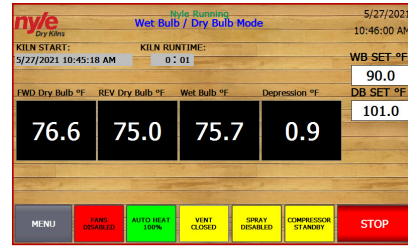

Temperature & Setpoints:

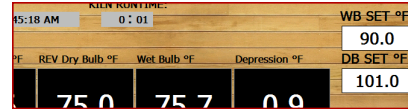

This section shows the actual temperatures;

FWD - The temperature of the dry bulb sensors in front of the fan wall (if fans are moving in the forward position)

REV - The temperature of the dry bulb sensors behind the fan wall (if fans are moving in reverse)

WET - The average temperature of the wet bulb sensors.

Wet Bulb > Wet Bulb Setpoint = Vents will open

Wet Bulb < Wet Bulb Setpoint = Vents will close

Note: the FWD or REV value that is highlighted in blue indicates which direction the fans are moving. In this case they are running in reverse.

Dry Bulb Set points & Wet Bulb Set points are the current set points used to control. If the schedule is enabled, schedule values are shown on the schedule screen. If the schedule is disabled, these values become "live editable" and the controller will follow the values you enter here.

Kiln Start & Runtime:

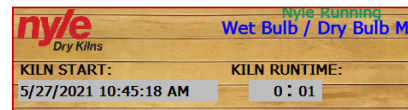

This section logs the start time of the cycle and how long its been running for.

Trend Screen

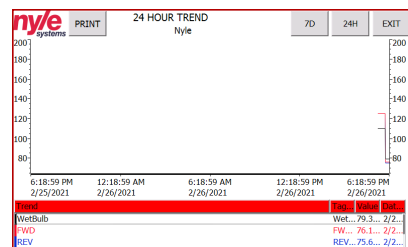

From the trend screen, the user can see all of the graphs for the kiln cycle. Note: the user can toggle between a 24 hour & 7 day view by using the buttons on the top right of the screen.

Setup Screen

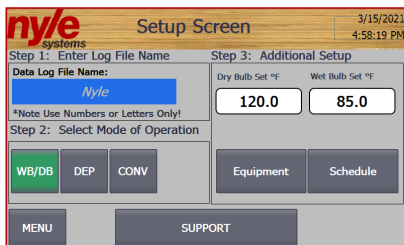

From the Setup screen, the user can set the Log File Name, Select the Mode of operation and navigate to the Schedule and Support Screens.

Log File Name:

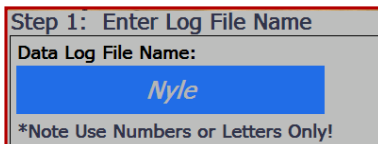

Under this step the user can select the name that the kiln cycle will be recorded under in the data log.

Select Mode of Operation:

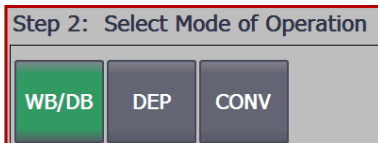

Under this step the user can select the mode of operation for the kiln. The user can choose from three modes of operation; Wet Bulb/ Dry Bulb, Depreciation or Conventional.

Wet Bulb / Dry Bulb Mode: This mode controls our standard dehumidification system via a wet bulb temperature inside the kiln. The controlling dry bulb (dry bulb based on fan direction) controls the heat output and the exhaust vents.

Depression Mode: This mode controls the heat based on the controlling dry bulb (dry bulb based on fan direction). Either our standard dehumidifications system or the exhaust vents are controlled via the depression inside the kiln (Controlling Dry Bulb Temp – Wet Bulb Temp).

Example: 140F Dry Bulb – 100F Wet Bulb = 40F Depression

Conventional Mode: This mode controls the heat based on the controlling dry bulb (dry bulb based on fan direction). The exhaust vents are controlled by the wet bulb temperature.

Schedule Screen

Step	WB Set	DB Set	Dep Set	EMC %	Fan Speed	Hrs
1	0	0	0	0	0	0
2	0	0	0	0	0	0
3	0	0	0	0	0	0
4	0	0	0	0	0	0
5	0	0	0	0	0	0
6	0	0	0	0	0	0
7	0	0	0	0	0	0
8	0	0	0	0	0	0

The Schedule Screen has 8 time based steps. For each step you can set;

WB Set - Will call Vent to open when Wet Bulb actual is above this value and to close when below.

DB Set - Will call for Heat to come on when Dry bulb is below this value and will shut off when above.

Fan Speed - Percentage of VFD output. Can be 100% with wood MC above 28% and 80% when below 28%

Hrs - Time to run in this step before progressing to the next step.



Current schedule can be Saved or Loaded from memory.



Takes you back to the Setup Screen.



These buttons enables / disables the Schedule function. When "Enabled" is green, the controller will follow the schedule as per the schedule screen. When "Disabled" is red, the controller will follow the Dry bulb set point and Wet bulb set point, settable "live" on the home screen.

Incase of kiln power failure during schedule

If your kiln experiences power failure during a schedule your kiln will power back up and start the schedule over. To resume where you left off you must;

- Stop the kiln
- Changes the completed steps "Hrs" to 0
- Start the Kiln

Note: Be sure to save this schedule under a different name

Schedule Controls

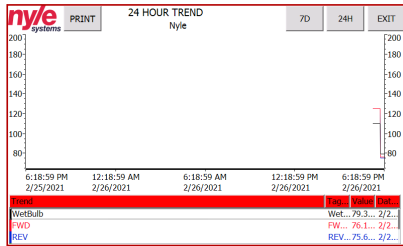

Entering a Schedule

A new schedule can be entered either manually or by pressing the LOAD button. If no previous schedules have been saved, the HMI will not be able to load a schedule into the PLC control. Navigate to the SETUP screens and then to Schedule to begin the schedule control process.

On the main schedule screen the full 8 step schedule that is currently loaded into the PLC will be displayed. To change values in that schedule simply touch on the desired set-point, enter a new value, and press the return key. Once satisfied with the currently loaded schedule, press the "Enabled" key to run via the automatic set point changing schedule control.

Saving a Schedule

If you would like to SAVE a schedule for later use, first enter into the PLC as described above. Once you are satisfied with the currently loaded schedule press the "Save" button to display the save schedule interface. You may verify the schedule about to be saved by pressing the up and down arrows displayed on the left of the screen. Press the arrow facing left to begin the save process. A pop-up will appear verifying the save command. Press "Yes" followed by "Save As" to rename the schedule in a way that makes sense for the schedule. See image above.

Loading a Saved Schedule

Once a schedule has been saved, it can be reused over and over for efficient drying processes. To load a schedule, navigate to the schedule setup screen. Press the "Load" button to begin the loading process. Press the left arrow once, and press on the schedule you want to load into the PLC. Pressing the "Back" button pushes the new schedule into the PLC for runtime. Verify the loaded schedule before pressing the "Enabled" key.

Data Logging

Starting a Data Log

Logging data with the NSC100 control is simple. Just by entering a LOTID and pressing the start button automatically begins the data logging process. The control is capable of storing up to 2 complete cycle logs in most cases. Once the data log storage space has been filled up on the PLC, an operator message will appear requiring the download and clearing of the logs through the retrieval system.

A log bypass option is available if the data log is not required. To access this operation press "SETUP" and afterwards "SUPPORT". This operator screen will display all system real time data and the log bypass button. Press the log bypass button to disable the data log function.

Retrieving a Data Log

All data logs are stored on the PLC memory card as a CSV data log file. To obtain the data logs the kiln operator may either log into the PLC via the web interface or pull the SD card and copy over the files to a computer.

To retrieve the data through the web interface, enter the IP address of the connected PLC into a web browser connected to the same local area network. Click "ENTER" to proceed into the default Siemens web interface. Login using supplied login from Nyle Systems. Click on "DATA LOGS" to view, download and clear the data logs stored on the PLC. Each log file will have the same name as the LOT ID that was entered when starting the kiln cycle.

Remote Access

Password Change & VNC / WEB Remote Access Configuration

The HMI screen will be configured to enable VNC and HTTP web remote access when shipped. However, you may need to set up remote access after an upgrade or replacement of the HMI, follow the steps below.

Enter the control menu by pressing the top right corner of the screen on the clock.

When you are in the control menu, click on WinCC Internet Settings



VNC:

1. Choose the "Remote" tab and click the "Change Settings" button

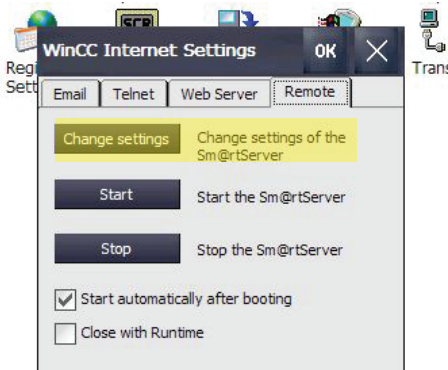

2. Choose the "password 1" box and set the password to the default password of "100" or a user selected password. **Note: if the Master password is lost a service charge will be required for a reload of the firmware.**

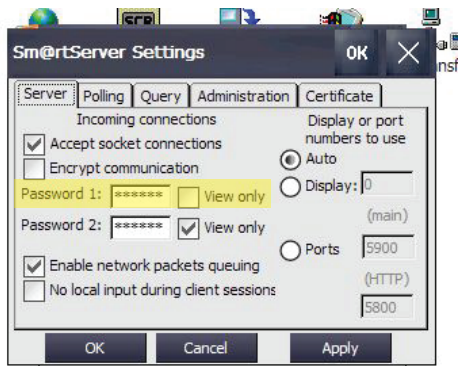

3. Apply and choose yes to restart.

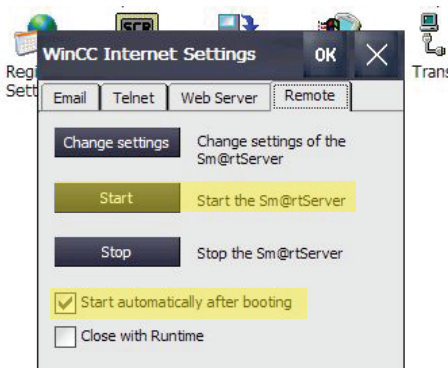

4. Check the "Start automatically after booting" box.
5. Press the "Start" button and press OK. You will now have remote access to this HMI.

WEB Server:

1. Choose the "Web Server" tab



2. Check the "start automatically after booting" Box.
3. Click "User Administration"

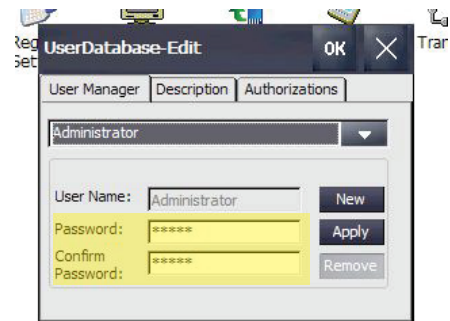

4. Under the "User Manager", Change the password and confirm password to the default password of "100" or a user selected password. **Note: if the Master password is lost a service charge will be required for a reload of the firmware.**
5. Apply and choose OK and then select yes to restart.

Setting up Remote Access with VNC Viewer

Note: ask your local IT support to set this up.

To remote into the HMI screen from another device, the user will need to install a program called VNC Viewer. The link for this program is;

<https://www.realvnc.com/en/connect/download/viewer/>

After the VNC Viewer is installed, the user will need to set up a connection to the HMI screen. To do this, enter the IP Address of your HMI screen in the search bar at the top of the window in VNC Viewer. The search bar will read Enter a VNC Search address or search. This is where the user will enter in the IP

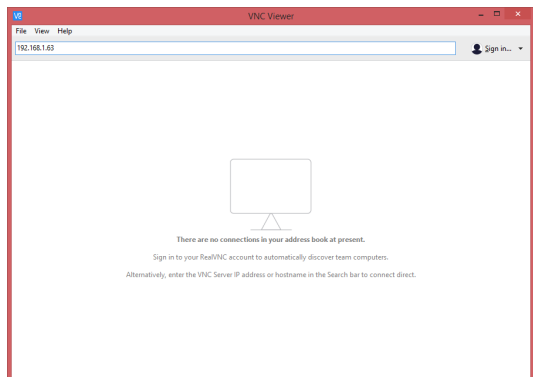

address and press enter.

When the enter key is pressed, a window will pop up asking for a password. The password will always

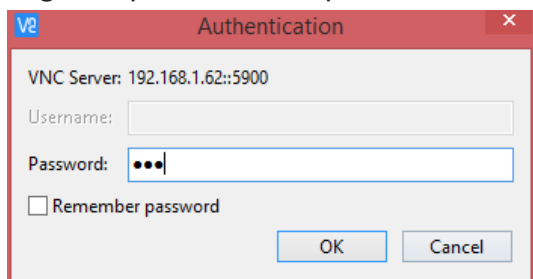

be 100 unless set by the user.

Type in 100 or the defined password and then press OK or enter. This will bring up the same screen that is displayed on the HMI screen and the user will be able to monitor or change values as the user would be able to on the HMI screen.

Love Kiln Controls



The kiln controller is set up like a modern, microprocessor based, electronic circuit which assures an exact measurement of wood moisture content, with automatic adjustment of kiln temperature, without need of any regulation by the user and without using any correction table for wood temperature, because all corrections are automatically made by the microprocessor. This instrument has been specially designed to assure long-time endurance and great simplicity of use: these targets have been achieved using high-quality materials and a large LCD display able to give all necessary indications at a glance.

Controller Display

The programming for the controller is broken down into three menus (Operation, Regulation, and Initial Setting). Upon normal operation, control will be in the Operation Menu.

Pressing the INDEX key will cycle through the menu items. The parameter will be displayed in the top display, while its value will be displayed in the bottom display, except for the set point which is displayed in the bottom display on the Home Display. The UP and DOWN arrows change the values of the parameters. The ENTER key must be pressed after any changes.

Using the Controller

To turn on the controller turn the system switch to the ON position.

At power-on time, the instrument model and software version visualization will show briefly, then the display will look like above image (values shown may be different).

If an error is displayed instead of the temperature values, please check the connection of the temperature probes.



Index: pressing the index key advances the display to the next menu item.



Up arrow: increments a value or changes a menu item. If pressed during the operation mode, the set point value will be increased.



Down arrow: decrements a value or changes a menu item. If pressed during



the operation mode, the set point value will be decreased.

Enter: stores the value or item change. If not pressed, the previously stored value or item will be retained. When pressed during the operation mode, the controller switches to the regulation mode. If held for more than 3 seconds during the operation mode, the controller switches to the initial setting mode. If pressed during the regulation mode or initial setting mode, the controller will return to the operation mode.

Parameters

SYSTEM OFF/ON SWITCH: This switch energizes the digital controllers, the entire control circuit (enabling heat, exhaust, humidification and refrigeration), and starts the internal blower. If the blower motor trips its motor circuit protector, the entire system will shut down.

HEAT OFF/AUTO SWITCH: In the "AUTO" position, the auxiliary heat will operate in response to the dry bulb controller. If the kiln temperature is lower than the dry bulb set-point, the heat system will be on. In the "OFF" position, the heat will not operate.

EXHAUST OFF/AUTO SWITCH: The "AUTO" position allows the exhaust vents to operate in response to the dry bulb controller. If the kiln temperature is higher than the dry bulb set-point, the vents will open. In the "OFF" position the vents will not open.

REFRIGERATION OFF/AUTO SWITCH: The "AUTO" position allows the refrigeration to operate in response to the wet bulb controller. If the wet bulb temperature is higher than the wet bulb set-point, the compressor will start. In the "OFF" position, the compressor will not run. On some units, there is an interlock that will prevent the refrigeration system from operating when the wet bulb is below 85° F. or above 121° F.

DRY BULB CONTROLLER: The dry bulb temperature of the kiln is indicated on the upper display (PV) of the dry bulb controller. The set-point is indicated on the bottom display marked (SV). To make a set-point change use the RAISE or LOWER key, to desired set-point. Then press the enter key to save changes. The ALM 1 indicator will light whenever the kiln temperature is above set-point by 2° F., and triggers the exhaust

circuit. Both lights should not be lit at the same time, if so consult factory for proper program configuration. Both lights will be off when kiln temperature is at or near the set-point. NOTE: PV means process value or actual kiln conditions. SV means set value or the setting the system is trying to reach.

WET BULB CONTROLLER: The wet bulb is related to the humidity in the kiln, and the refrigeration system operates to lower the wet bulb. This means that the compressor will operate when OUT 2 indicator is lit. ALM 1 indicator should be used if there is a humidification system being used to raise the humidity in the kiln. If the wet bulb temperature is above 120° F., the exhaust vents will open even if the exhaust switch is "off".

PATENTED XDH DAMPER SYSTEM: This patented damper system is responsible for NYLE drying systems being the most technically advanced, and efficient dehumidifiers available. The dampers allow water removal all the way to 160° F., while assuring that the compressor remains cool and not overworked. This system is why NYLE can offer excellent warranties and low drying costs. For further information on the theory of operation, please refer to the refrigeration section.

AUTOMATIC DAMPER OPERATION: The louver damper in front of the cold coil is positioned with a proportioning motor. This motor will modulate open or closed with a signal from a thermostat. This thermostat is located on in the front under the temperature controls. It is normally a Honeywell model that is 2" by 2", with a dial. Verify its location and that it is set for 75° F.

When the compressor begins to run cold, the thermostat will sense this and open the center damper to allow more air through the coil. If the amount of heat was sufficient to bring the temperature back up to 75° F., the damper will stop moving. The response time of the sensor, and the speed of the motor, the dampers are always moving to "hunt" for the correct position, because of lag time for the cold coil to soak up heat.

To check operation (only if compressor is running), increase the thermometer setting to maximum which should open center dampers completely. Decreasing setting to minimum will close center dampers. If dampers move correctly, but not to extremes, check the linkages for binding.

If dampers do not move at all, contact a technician at the factory. If a technician is not available, and lumber drying must continue, decrease kiln temperature to below 120° F. Make a mark on the linkage to distinguish the original location, then loosen the ball-socket joint on the motor crank arm, and position the damper at its midpoint, at position equal to 75° F. suction temperature. This will allow water removal until a repair can be made.

Warning

DO NOT set dry bulb temperature above 160° F. or wet bulb temperature above 120° F.

DO NOT operate compressor below 75° F. dry bulb or if the wet bulb is over 120° F., lower the dry bulb by the number of degrees the wet bulb exceeds 120° F.

Example: If the dry bulb is 140° F. and the wet bulb is set at 120° F. but running at 124° F., Lower the dry bulb to 136° F. so the wet bulb will drop.

DO NOT tamper with the controls programming without consulting a Nyle professional. Nyle controllers are factory programmed by professionals with years of experience programming dehumidification units. Tampering with the programming could result in reduced function of your unit.

Alarms

0. Alarm function disabled
1. Deviation upper- and lower-limit: This alarm output operates when PV value is higher than the setting value SV+(AL-H) or lower than the setting value SV-(AL-L).
2. Deviation upper-limit: This alarm output operates when PV value is higher than the setting value SV+(AL-H).
3. Deviation lower-limit: This alarm output operates when PV value is lower than the setting value SV-(AL-L).
4. Reverse deviation upper- and lower-limit: This alarm output operates when PV value is in the range of the setting value SV+(AL-H) and the setting value SV-(AL-L)
5. Absolute value upper- and lower-limit: This alarm output operates when PV value is higher than the setting value AL-H or lower than the setting value AL-L.

6. Absolute value upper-limit: This alarm output operates when PV value is higher than the setting value AL-H.
7. Absolute value lower-limit: This alarm output operates when PV value is lower than the setting value AL-L.
8. Deviation upper- and lower-limit with standby sequence: This alarm output operates when PV value reaches set point (SV value) and the value is higher than the setting value SV+(AL-H) or lower than the setting value SV-(AL-L).
9. Deviation upper-limit with standby sequence: This alarm output operates when PV value reaches set point (SV value) and the reached value is higher than the setting value SV+(AL-H).
10. Deviation lower-limit with standby sequence: This alarm output operates when PV value reaches the set point (SV value) and the reached value is lower than the setting value SV-(AL-L).
11. Hysteresis upper-limit alarm output: This alarm output operates if PV value is higher than the setting value SV+(AL-H). This alarm output is OFF when PV value is lower than the setting value SV+(AL-L).
12. Hysteresis lower-limit alarm output: This alarm output operates if PV value is lower than the setting value SV-(AL-H). This alarm output is OFF when PV value is higher than the setting value SV-(AL-L).

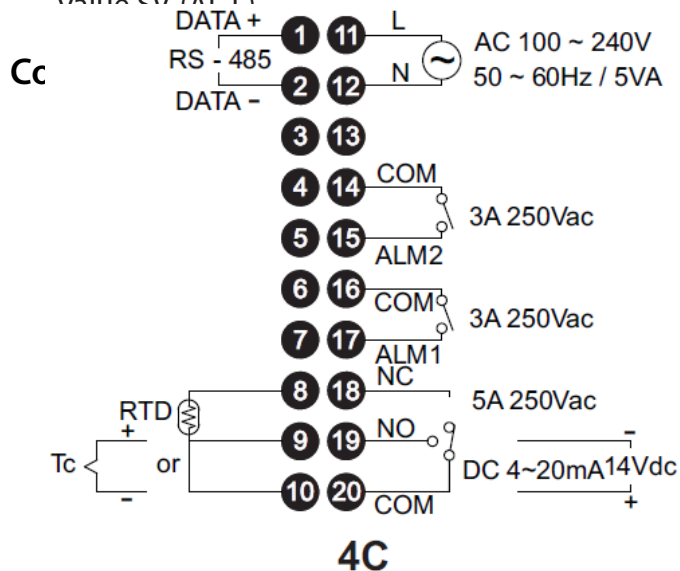

Drying Lumber

Loading the Drying Chamber

The USDA Dry Kiln Operators Manual describes, in Section 5, the proper method of stacking and placing stickers in the lumber. Nyle recommends that these guidelines be followed carefully.

Placing Stickers and Loading Lumber

- Stickers should all be at least $\frac{3}{4}$ " thick and all sticks in any load must be the same thickness.
- Thick lumber (10/4 " and thicker) should be dried using double stickers.
- End stickers should be as close to the ends of the boards as possible.
- The sticker spacing should be approximately 18". This spacing can be reduced to 12" if excessive warping, cupping, and bow are a problem.
- Keep stickers in a vertical line and always support the load under each sticker.
- If you have some wide boards, or other pieces that you want to keep as straight as possible, pile them on the bottom as the weight of the lumber above will constrain the wide boards and give the best result.
- If a less than full load is anticipated, it is better to reduce the depth rather than the height or width. This will obviously leave the stickers "hanging out", but will result in better drying.

Insuring Proper Airflow

- When the lumber is fully loaded, the baffles should be lowered to the top of the lumber and the side baffles should be carefully positioned. If no side baffles are installed, the space could be closed off with plywood or boards.
- Do not use plastic sheeting as it may come loose and become entangled in the fans.
- If the load supports are thicker than normal stickers, the extra space should be blocked with a narrow board or lath.
- Close off any large openings that will let air go around the lumber. Air will always take the path of least resistance, and you must force it through the stickered pile.

- A small amount of time spent doing this correctly will pay back in more even, faster, and less expensive drying.

Drying Schedules

Each species of lumber has a maximum rate of drying (expressed as % loss/day) that can be tolerated without damage. These rates have been determined through experimentation by the U.S. Dept. of Agriculture, various universities and others. Schedules have been developed based on time, dry bulb-wet bulb temperatures, and even automatic moisture content devices. Due to the many important variables that affect drying such as kiln chamber heat loss, air velocity, ambient temperature and humidities, vapor leaks, etc., the most important consideration of a schedule is that you maintain a safe drying rate.

The HT-Series drying system dries lumber by using the dry bulb and wet bulb temperatures of the kiln to control the operation of the dehumidifier. The schedules on pages 32-43 are based on dry bulb and wet bulb conditions (humidity). These schedules are starting points; you will probably change these over time because you will find different settings work for you. This is due to the fact that different people saw boards differently, stack lumber differently, build chambers differently, etc.

If the dry bulb temperature is above 80°F., and the wet bulb is 2°F above its set point, (factory setting) the compressor will turn on. When the compressor is on, moisture is being condensed on the cold coil in the unit, and draining away. This moisture being removed reduces the humidity, dropping the wet bulb temperature.

The drying rates on page 44 are the rates to follow when first using the machine. These rates can be safely exceeded by an additional 50% (i.e., 1.0% can be raised to 1.5% and 3.3% can be increased to almost 5%) given careful judgment and operating experience for Groups 1, 2, and 3. Top quality moisture meters, or weight samples, must be used at these higher drying levels to avoid lumber damage. Some hardwoods such as Southern Red Oak, White Oak, and Group 4 hardwoods should not use any sort of accelerated schedule.

Wood Groups

Group 1
4/4 Softwoods
4/4 Soft Hardwoods
Group 2
4/4 Medium Hardwoods
8/4 Softwoods
8/4 Soft Hardwoods
Group 3
4/4 Hardwoods
8/4 Medium Hardwoods
Group 4
8/4 Hardwoods

Lumber Types

Softwood			
Cedar, Eastern White	Pine, Red (Norway)	Spruce, White	
Fir, Balsam	Pine, Eastern White		
Hemlock, Eastern	Spruce, Black		
Larch, Eastern	Spruce, Red		
Soft Hardwoods			
Aspen			
Basswood			
Cottonwood			
Poplar			
Medium Hardwood			
Ash, Black	Birch, Yellow	Maple, Soft	Walnut
Ash, White	Cherry, Black	Maple, Hard	
Beech	Elm, White	Sweet gum (Red gum)	
Birch, White	Hickory	Tupelo (Black gum)	
Hardwoods			
Elm, Rock			
Oak, Red			
Oak, White			

Moisture Removal Rates

Moisture Removal Rate Per Day (Maximum): These removal rates are estimates only. Always check your actual removal rates daily, using an accurate moisture meter. There are many variables that affect drying rates, such as how lumber is sawn, stacked, and how the chamber is built. *Drying rate may be too high, look at the maximum rates on pages 44 & 45.*

- Drying Group 1 woods at a rate of less than 5% per day may result in mold or staining of the lumber.
- Drying Group 3 woods at a rate greater than 3.5% per day may result in checking or other degrade to the lumber.

Drying Time

The time the lumber takes to dry is a function of the lumber itself, the drying schedule and the capacity

of the XDH system. The schedule is usually predetermined and the lumber will give up the water at a certain rate. It is helpful to know how much water must be removed during the drying cycle. When comparing this with the capacity of the XDH System a predicted drying time can be estimated.

To calculate the total water to be removed, look up the weight per 1000 BF of 8% lumber. Multiply this by 92 to obtain the dry weight. The water is the calculated as follows.

Eastern White Pine at 8% MC=2020 #/MBF

Therefore: (92.) (2020)=1858 #/MBF Oven Dry Weight

How much water to be removed from

25,000 Board feet of pine @ 65% drying to 12%
 $(.65-.12) (1858) (25) = 24,619 \text{ # H}^2\text{O}$

If your dryer can remove 3,500 pounds per day this load would take 7 days. Since 4/4 pine can be dried safely in this time, then the schedule is reasonable. However, 8/4 cannot be dried safely in this time so a longer schedule would be planned.

Procedures for Drying Softwood

1. Turn on SYSTEM, HEAT, FANS (Auto) switches. Set dry bulb temperature to heat kiln to about 80°F (27°C) or more.
2. Turn HEAT switch off. Turn on COMPRESSOR and EXHAUST switches. Set dry bulb control to 120°F (49°C) and wet bulb setting at 75°F (24°C). This will cause the compressor to run constantly.
3. When the dry bulb reaches 120°F (49°C), raise the dry bulb set point by the number of degrees that the wet bulb is below 115°F (45°C). For example, when the kiln reaches 120°F, if the wet bulb is 115°F, you would do nothing because the wet bulb is not below 115°F. However if when you reach a dry bulb temperature of 120°F, the wet bulb temperature is 110°F, you would raise the dry bulb set point to 125°F (the 5° that the wet bulb is below 115°F). You continue to do this each day.
4. When 1/3 of the lumber has reached the target moisture content and the target is 10%–12%MC; set the conditions in the kiln at 130°F dry bulb and 115°F wet bulb. If the target MC is 6%–8%, set the conditions at 145°F dry bulb

and 115°F wet bulb. If the target MC is 15%, set the conditions at 125°F dry bulb and 115°F wet bulb. These setting will stop the wood that has reached the desired MC from drying further, and allows the wetter wood to continue drying. This step is called "EQUALIZATION". Leave the settings at these points until all the lumber has reached the desired moisture content.

5. **CONDITIONING.** This step is usually not required for softwoods dried with the above procedure. Conditioning may be required if you wait too long to start Step 4, as some of the lumber will be over dry and it will be desirable to add moisture. For this reason, it is better to start Equalization (4) too early rather than too late.

Procedures for Drying Softwood (Depression)

1. Turn on SYSTEM and set FANS, COMPRESSOR, and EXHAUST switches to auto. Set the Dry Bulb to 120° (top switches) and the Depression for 50°. This will cause the compressor to run constantly.
2. When the dry bulb (red pen) reaches 120°, raise the dry bulb setting by an amount that the depression is more than 5°. For example, when the red pen reaches 120°, if the green pen is showing less than 5°, you would do nothing. But if the green pen is showing 10°, you would raise the dry bulb setting to 125°. You continue to do this every day.
3. When 1/3 of the lumber has reached the target moisture content, and the target is 10%-12%, set the dry bulb for 130°, and the depression for 15°. If the target is 6%-8%, set the dry bulb for 145° and the depression for 30°. If the target is 15%, put the settings 125°/10°. These settings will stop the wood that has reached the desired moisture content from drying further and allows the wetter wood to continue drying. This step is called equalization. Leave the settings at this point until all the wood has reached the desired moisture content.
4. **Conditioning:** This step is not usually necessary for softwoods dried with the above procedure. Conditioning may be required if you wait too long to start step 3, as some lumber will become over dried and it will be necessary to add moisture back into the wood. It is better to start step 3 too early rather than too late.

HT - Series Drying Schedules

The provided drying schedules are intended to be used as guides for initial use. Experience and close monitoring of the charge should allow you to develop schedules more closely suited to your application.

The temperature settings listed in the schedules are set points, designed as limits of operation rather than the actual dry kiln conditions at all times. For example, if a step calls for moving from 120/110 to 130/110, the temperature will not immediately move to the new settings. The dry bulb and wet bulb will rise slowly and then the wet bulb will drop slowly. Often, the conditions set for wet bulb will not be reached until the step is nearly completed. Over time you will learn what to expect so you can survey the performance on a day to day basis and create your own schedules.

When following the schedules listed in this or any other manual, do not adjust the dry bulb upward if it will result in the wet bulb exceeding 120° F, even if the schedule at that point may call for a higher setting. The only reason for increasing dry bulb settings is to increase the rate that water is evaporated from the wood. If the water is evaporating at a rate that will maintain a 120° F wet bulb, then it is not necessary to raise the dry bulb.

Example: the schedule for a charge of lumber at 35% calls for 140°/115°. The kiln is now operating at a setting of 135° F. WB, but is actually operating at 135° F. DB and 119° F. WB and the compressor is running continuously. Increasing the dry bulb at this point will not increase drying because the compressor is already operating continuously. If the wet bulb drops to the 115° F. set point then it would make sense to advance the dry bulb to 140° F. Never operate the kiln with a dry bulb over 160° F or wet bulb over 120° F

Drying Schedules - *Never operate the Kiln with a dry bulb over 160° F or wet bulb over 120° F*

Ash 5/4

Aspen 4/4, 5/4, 6/4, 8/4

% MC	DB Temp (°F)	WB Temp (°F)	DEP	% MC	DB Temp (°F)	WB Temp (°F)	DEP
GREEN - 35	110	105	5	Green - 60	125	110	15
35 - 30	110	103	7	60-50	130	100	30
30 - 25	120	110	10	50-40	135	100	35
25 - 20	130	110	20	40-35	140	100	40
20 - 15	140	110	30	35-30	150	100	50
15 - FINAL	150	110	40	30-Final	160	100	60

Bald Cypress 4/4

Balsa 4/4

% MC	DB Temp (°F)	WB Temp (°F)	DEP	% MC	DB Temp (°F)	WB Temp (°F)	DEP
GREEN - 60	110	92	18	GREEN - 50	100	80	20
60 - 50	120	113	7	50 - 40	105	80	25
50 - 30	130	114	16	40 - 35	120	95	25
30 - 25	140	115	25	35 - 30	130	105	25
25 - 20	150	115	35	30 - 25	140	110	30
20 - FINAL	160	115	45	25 - 20	150	110	40
				20 - FINAL	160	115	45

Beech 4/4

Black Ash 4/4, 5/4, 6/4

% MC	DB Temp (°F)	WB Temp (°F)	DEP	% MC	DB Temp (°F)	WB Temp (°F)	DEP
GREEN - 40	115	109	6	GREEN - 50	120	111	9
40 - 35	120	113	7	50 - 40	125	114	11
35 - 30	124	115	9	40 - 35	130	115	15
30 - 25	132	115	17	35 - 30	130	105	25
25 - 20	140	115	25	30 - 25	140	100	40
20 - 15	150	115	35	25 - 20	150	100	50
15 - FINAL	160	110	50	20 - FINAL	160	110	50

Black Ash 8/4

Black Locust 4/4

% MC	DB Temp (°F)	WB Temp (°F)	DEP	% MC	DB Temp (°F)	WB Temp (°F)	DEP
GREEN - 50	120	115	5	GREEN - 30	100	92	8
50 - 40	120	113	7	30 - 25	110	98	12
40 - 35	120	109	11	25 - 20	130	114	16
35 - 30	120	101	19	20 - 15	140	115	25
30 - 25	130	95	35	15 - 10	150	115	35
25 - 20	140	90	50	10 - FINAL	160	115	45
20 - 15	150	110	40				
15 - FINAL	160	110	50				

Black Walnut 4/4, 5/4, 6/4

% MC	DB Temp (°F)	WB Temp (°F)	DEP	% MC	DB Temp (°F)	WB Temp (°F)	DEP
Green - 50	120	113	7	Green - 50	110	105	5
50 - 40	120	110	10	50 - 40	110	103	7
40 - 35	120	105	15	40 - 35	110	99	11
35 - 30	120	95	25	35 - 30	110	91	19
30 - 25	130	90	40	30 - 25	120	90	30
25 - 20	140	90	50	25 - 20	130	90	40
20 - 15	150	100	50	20 - 15	140	90	50
15 - 6	155	120	35	15-Final	160	110	50

Black Walnut 8/4**Butternut 5/4**

% MC	DB Temp (°F)	WB Temp (°F)	DEP	% MC	DB Temp (°F)	WB Temp (°F)	DEP
GREEN - 60	100	94	6	GREEN - 50	105	80	25
60 - 50	100	92	8	50 - 40	120	101	19
50 - 40	110	96	14	40 - 35	130	101	29
40 - 35	120	95	25	35 - 30	140	115	25
35 - 30	125	95	30	30 - 25	145	115	30
30 - 25	130	95	35	25 - 20	150	115	35
25 - 20	140	95	45	20 - FINAL	160	115	45
20 - 15	150	100	50				
15 - FINAL	160	110	50				

Ceiba 4/4**Ceiba 8/4**

% MC	DB Temp (°F)	WB Temp (°F)	DEP	% MC	DB Temp (°F)	WB Temp (°F)	DEP
GREEN - 50	105	91	14	GREEN - 35	110	115	-5
50 - 40	120	107	13	35 - 30	120	114	6
40 - 35	130	115	15	30 - 25	130	115	15
35 - 30	135	115	20	25 - 20	140	115	25
30 - 25	140	115	25	20 - 15	150	100	50
25 - 20	150	115	35	15 - FINAL	160	110	50
20 - FINAL	160	115	45				

Cherry 4/4, 5/4, 6/4**Cherry 8/4**

% MC	DB Temp (°F)	WB Temp (°F)	DEP	% MC	DB Temp (°F)	WB Temp (°F)	DEP
GREEN - 35	120	112	8	GREEN - 40	100	96	4
35 - 30	125	115	10	40 - 35	105	100	5
30 - 25	130	116	14	35 - 30	110	104	6
25 - 20	135	113	22	30 - 25	115	103	1055
20 - 15	150	115	35	25 - 20	125	105	20
15 - FINAL	160	110	50	20 - 15	130	113	17

Cocbolo 4/4

15 - FINAL	140	115	25
------------	-----	-----	----

Cottonwood 8/4

% MC	DB Temp (°F)	WB Temp (°F)	DEP
GREEN - 70	95	77	18
70 - 60	105	87	18
60 - 50	120	101	19
50 - 40	130	105	25
40 - 30	140	115	25
30 - 25	150	115	35
25 - FINAL	160	115	45

Cumaru, Muiraoiranga 4/4

% MC	DB Temp (°F)	WB Temp (°F)	DEP
GREEN - 40	100	97	3
40 - 35	105	99	6
35 - 30	110	103	7
30 - 25	120	110	10
25 - 20	130	111	19
20 - 15	140	115	25
15 - 11	150	115	35
11 - FINAL	160	115	45

Cypress 4/4

% MC	DB Temp (°F)	WB Temp (°F)	DEP
GREEN - 60	120	110	10
60 - 50	125	113	12
50 - 40	130	114	16
40 - 35	135	115	20
35 - 25	140	115	25
25 - 20	150	110	40
20 - FINAL	160	115	45

Cypress 8/4

% MC	DB Temp (°F)	WB Temp (°F)	DEP
GREEN - 40	120	110	10
40 - 35	120	105	15
35 - 30	130	110	20
30 - 25	140	110	30
25 - 20	150	110	40
20 - 15	160	120	40
15 - FINAL	160	115	45

Eastern Hemlock 4/4

% MC	DB Temp (°F)	WB Temp (°F)	DEP
GREEN - 40	120	110	10
40 - 35	125	110	15
35 - 30	140	110	30
30 - 25	150	110	40
25 - FINAL	160	110	50

Eastern Hemlock 8/4

% MC	DB Temp (°F)	WB Temp (°F)	DEP
GREEN - 40	120	115	5
40 - 35	125	118	7
35 - 30	129	118	11
30 - 25	130	116	14
25 - 20	139	118	21
20 - 15	140	114	26
15 - FINAL	160	114	46

Eastern Red Cedar 4/4, 5/4, 6/4**(To preserve oil)**

% MC	DB Temp (°F)	WB Temp (°F)	DEP
GREEN - 30	120	113	7
30 - 25	120	107	13
25 - 20	130	110	20
20 - 15	140	114	26
15 - FINAL	160	110	50

Eastern Red Cedar 8/4**(To preserve oil)**

% MC	DB Temp (°F)	WB Temp (°F)	DEP
GREEN - 30	120	115	5
30 - 25	120	111	9
25 - 20	130	116	14
20 - 15	135	113	22
15 - FINAL	160	110	50

Eastern White Pine Furniture 4/4
(Anti-brown stain)

% MC	DB Temp (°F)	WB Temp (°F)	DEP
GREEN - 60	110	95	15
60 - 50	115	95	20
50 - 40	120	95	25
40 - 35	125	95	30
35 - 30	130	95	35
30 - 25	140	105	35
25 - 20	150	115	35
20 - 15	155	115	40
15 - FINAL	160	110	50

Eastern White Pine Furniture 8/4
(Anti-brown stain)

% MC	DB Temp (°F)	WB Temp (°F)	DEP
GREEN - 60	110	100	10
60 - 50	115	100	15
50 - 40	120	100	20
40 - 35	125	100	25
35 - 30	130	100	30
30 - 25	135	100	35
25 - 20	140	100	40
20 - 15	150	110	40
15 - FINAL	160	110	50

**Equalize and condition - target EMC*

Hard Maple 4/4, 5/4
(White wood schedule)

% MC	DB Temp (°F)	WB Temp (°F)	DEP
GREEN - 40	100	87	13
40 - 35	105	90	15
35 - 30	110	90	20
30 - 25	120	85	35
25 - 20	120	80	40
20 - 15	140	100	40
15 - FINAL	160	115	45

Hard Maple 4/4, 5/4
(White wood schedule)

% MC	DB Temp (°F)	WB Temp (°F)	DEP
GREEN - 40	105	93	12
40 - 35	110	96	14
35 - 30	115	98	17
30 - 25	120	85	35
25 - 20	120	80	40
20 - 15	140	100	40
15 - FINAL	160	115	45

** The key to keeping Maple bright is having lots of airflow and not letting the dry bulb go over 120° until the wood is below 20% moisture content - Maintain target drying rates.*

Hard Maple Squares 2 1/2"
(End coated)

% MC	DB Temp (°F)	WB Temp (°F)	DEP
GREEN - 35	110	105	5
35 - 30	115	107	8
30 - 25	120	106	14
25 - 20	130	105	25
20 - 15	150	115	35
15 - FINAL	160	110	50

Hard Maple Squares 3", 4"
(End coated)

% MC	DB Temp (°F)	WB Temp (°F)	DEP
GREEN - 30	110	107	3
30 - 25	110	105	5
25 - 20	120	112	8
20 - 15	125	110	15
15 - 10	145	107	38
10 - FINAL	160	110	50

Hickory or Pecan 4/4

% MC	DB Temp (°F)	WB Temp (°F)	DEP
GREEN - 50	110	105	5
50 - 40	115	109	6
40 - 35	120	112	8
35 - 30	125	109	16
30 - 25	130	105	25
25 - 15	150	100	50
15 - FINAL	160	110	50

Hickory or Pecan 8/4

% MC	DB Temp (°F)	WB Temp (°F)	DEP
GREEN - 50	95	89	6
50 - 40	105	99	6
40 - 35	110	102	8
35 - 30	120	110	10
30 - 25	130	105	25
25 - 15	150	100	50
15 - FINAL	160	110	50

Hickory White 4/4

% MC	DB Temp (°F)	WB Temp (°F)	DEP
GREEN - 40	95	89	6
40 - 35	100	95	5
35 - 30	105	98	7
30 - 25	110	98	12
25 - 20	120	110	10
20 - 15	150	115	35
15 - FINAL	160	115	45

Honduras, West Indies Mahogany 4/4

% MC	DB Temp (°F)	WB Temp (°F)	DEP
GREEN - 50	110	101	9
50 - 40	120	110	10
40 - 35	125	111	14
35 - 30	130	114	16
30 - 25	145	115	30
25 - 20	150	115	35
20 - 15	160	115	45
15 - FINAL	160	110	50

Honduras, West Indies Mahogany 8/4

% MC	DB Temp (°F)	WB Temp (°F)	DEP
GREEN - 40	110	105	5
40 - 35	110	103	7
35 - 30	110	99	11
30 - 25	120	101	19
25 - 20	130	95	35
20 - 15	140	90	50
15 - FINAL	160	110	50

IPE 4/4

% MC	DB Temp (°F)	WB Temp (°F)	DEP
GREEN - 40	100	98	2
40 - 35	110	106	4
35 - 30	115	111	4
30 - 25	120	110	10
25 - 20	130	105	25
20 - 15	140	115	25
15 - FINAL	160	115	45

KOA 4/4

% MC	DB Temp (°F)	WB Temp (°F)	DEP
GREEN - 40	105	95	10
40 - 35	110	96	14
35 - 30	115	98	17
30 - 25	125	98	27
25 - 20	140	90	50
20 - 15	150	100	50
15 - FINAL	160	110	50

Logpole Pine 4/4

% MC	DB Temp (°F)	WB Temp (°F)	DEP
GREEN - 40	120	110	10
40 - 35	125	110	15
35 - 30	140	110	30
30 - 25	150	110	40
25 - FINAL	160	110	50

Louro, Moena 4/4, 5/4, 6/4

% MC	DB Temp (°F)	WB Temp (°F)	DEP
GREEN - 45	100	90	10
45 - 35	110	102	8
35 - 30	120	112	8
30 - 25	130	113	17
25 - 20	140	114	26
20 - 15	150	115	35
15 - FINAL	160	115	45

Madrone 4/4

% MC	DB Temp (°F)	WB Temp (°F)	DEP
Green - 50	110	106	4
50 - 40	110	106	4
40 - 35	110	106	4
35 - 30	110	105	5
30 - 25	120	112	8
25 - 20	130	116	14
20 - 15	140	110	30
15 - 6	155	120	35

Mahogany 4/4, 5/4, 6/4

% MC	DB Temp (°F)	WB Temp (°F)	DEP
Green - 50	110	107	3
50 - 40	110	107	3
40 - 35	110	107	3
35 - 30	110	106	4
30 - 25	120	114	6
25 - 20	126	115	11
20 - 15	140	115	25
15 - 6	155	120	35

Mahogany 8/4

% MC	DB Temp (°F)	WB Temp (°F)	DEP
GREEN - 40	110	105	5
40 - 35	110	103	7
35 - 30	110	99	11
30 - 25	120	101	19
25 - 20	130	95	35
20 - 15	140	90	50
15 - FINAL	160	110	50

Melina 4/4

% MC	DB Temp (°F)	WB Temp (°F)	DEP
GREEN - 40	120	98	22
40 - 35	130	115	15
35 - 30	150	115	35
30 - FINAL	160	115	45

Myrtle 4/4

% MC	DB Temp (°F)	WB Temp (°F)	DEP
GREEN - 30	100	88	12
30 - 25	120	107	13
25 - 20	130	111	19
20 - 15	140	115	25
15 - FINAL	160	115	45

Myrtle 8/4

% MC	DB Temp (°F)	WB Temp (°F)	DEP
GREEN - 30	90	85	5
30 - 25	95	90	5
25 - 20	95	85	10
20 - 15	100	85	15
15 - 10	110	85	25
10 - FINAL	130	85	45

Northern Red Oak 4/4, 5/4, 6/4

% MC	DB Temp (°F)	WB Temp (°F)	DEP
GREEN - 50	110	106	4
50 - 40	110	105	5
40 - 35	110	102	8
35 - 30	120	106	14
30 - 25	125	100	25
25 - 20	135	100	35
20 - 15	140	100	40
15 - FINAL	160	110	50

Northern White Cedar 4/4, 5/4, 6/4

Northern White Cedar 8/4

% MC	DB Temp (°F)	WB Temp (°F)	DEP	% MC	DB Temp (°F)	WB Temp (°F)	DEP
Green - 35	130	116	14	GREEN - 35	125	116	9
35-30	135	115	20	35 - 30	125	112	13
30-25	140	106	34	30 - 25	135	115	20
25-20	150	116	34	25 - 20	140	115	25
20-15	155	105	50	20 - 15	150	115	35
15-final	160	110	50	15 - FINAL	160	110	50

*Equalize and condition - target EMC

Ohia 4/4

Persimmon 4/4

% MC	DB Temp (°F)	WB Temp (°F)	DEP	% MC	DB Temp (°F)	WB Temp (°F)	DEP
GREEN - 50	105	95	10	GREEN - 40	100	92	8
50 - 40	115	95	20	40 - 35	110	101	9
40 - 35	120	95	25	35 - 30	120	109	11
35 - 30	130	103	27	30 - 25	130	111	19
30 - 20	140	110	30	25 - 20	140	105	35
20 - 15	150	110	40	20 - 15	150	110	40
15 - FINAL	160	110	50	15 - FINAL	160	115	45

Poplar 4/4, 5/4, 6/4

Poplar 8/4

% MC	DB Temp (°F)	WB Temp (°F)	DEP	% MC	DB Temp (°F)	WB Temp (°F)	DEP
GREEN - 35	125	115	10	GREEN - 35	120	112	8
35 - 30	130	114	16	35 - 30	125	115	10
30 - 25	135	115	20	30 - 25	130	116	14
25 - 20	145	115	30	25 - 20	135	113	22
20 - 15	150	100	50	20 - 15	150	115	35
15 - FINAL	160	110	50	15 - FINAL	160	110	50

*Equalize and condition - target EMC

Red alder 4/4

Red Oak 4/4, 5/4, 6/4

% MC	DB Temp (°F)	WB Temp (°F)	DEP	% MC	DB Temp (°F)	WB Temp (°F)	DEP
GREEN - 50	100	85	15	GREEN - 50	110	106	4
50 - 40	120	95	25	50 - 40	110	105	5
40 - 35	130	111	19	40 - 35	110	102	8
35 - 30	140	115	25	35 - 30	110	96	14
30 - 25	150	110	40	30 - 25	120	90	30
25 - FINAL	160	115	45	25 - 20	130	90	40
				20 - 15	140	90	50
				15 - FINAL	160	110	50

*Equalize and condition - target EMC

Red Oak 8/4

% MC	DB Temp (°F)	WB Temp (°F)	DEP
GREEN - 50	110	107	3
50 - 40	110	106	4
40 - 35	110	104	6
35 - 30	110	100	10
30 - 25	120	95	25
25 - 20	130	90	40
20 - 15	140	90	50
15 - FINAL	160	110	50

Red Oak (Conservative Sch.) 4/4, 5/4

% MC	DB Temp (°F)	WB Temp (°F)	DEP
GREEN - 50	100	96	4
50 - 40	105	101	4
40 - 35	110	104	6
35 - 30	110	99	11
30 - 25	120	95	25
25 - 20	130	95	35
20 - 15	140	95	45
15 - FINAL	160	110	50

*Equalize and condition - target EMC

Red Oak (Conservative Sch.) 6/4, 8/4

% MC	DB Temp (°F)	WB Temp (°F)	DEP
GREEN - 50	100	97	3
50 - 40	105	102	3
40 - 35	105	100	5
35 - 30	110	103	7
30 - 25	120	100	20
25 - 20	130	95	35
20 - 15	140	95	45
15 - FINAL	160	110	50

Rock Elm 4/4, 5/4, 6/4

% MC	DB Temp (°F)	WB Temp (°F)	DEP
GREEN - 35	110	103	7
35 - 30	115	105	10
30 - 25	120	107	13
25 - 20	130	105	25
20 - 15	145	105	40
15 - FINAL	160	110	50

*Equalize and condition - target EMC

Rock Elm 8/4

% MC	DB Temp (°F)	WB Temp (°F)	DEP
GREEN - 35	110	106	4
35 - 30	110	105	5
30 - 25	120	112	8
25 - 20	130	116	14
20 - 15	140	110	30
15 - FINAL	160	110	50

Rosewood 4/4

% MC	DB Temp (°F)	WB Temp (°F)	DEP
GREEN - 40	110	106	4
40 - 35	110	105	5
35 - 30	115	108	7
30 - 25	120	106	14
25 - 20	130	100	30
20 - 15	140	100	40
15 - FINAL	160	110	50

*Equalize and condition - target EMC

Sapele 4/4

% MC	DB Temp (°F)	WB Temp (°F)	DEP
GREEN - 50	100	93	7
50 - 40	105	97	8
40 - 30	115	97	18
30 - 25	120	104	16
25 - 20	130	110	20
20 - 15	140	115	25
15 - FINAL	160	115	45

Siberian Larch 4/4

% MC	DB Temp (°F)	WB Temp (°F)	DEP
GREEN - 50	120	110	10
50 - 40	125	110	15
40 - 20	130	110	20
20 - FINAL	150	110	40

Soft Maple 4/4, 5/4, 6/4
(Bigleaf, Red, Silver)

Soft Maple 8/4

% MC	DB Temp (°F)	WB Temp (°F)	DEP	% MC	DB Temp (°F)	WB Temp (°F)	DEP
GREEN - 50	120	111	9	GREEN - 50	120	115	5
50 - 40	125	114	11	50 - 40	120	113	7
40 - 35	130	115	15	40 - 35	120	109	11
35 - 30	130	105	25	35 - 30	130	111	19
30 - 25	140	100	40	30 - 25	140	105	35
25 - 20	150	100	50	25 - 20	150	100	50
20 - FINAL	160	110	50	20 - FINAL	160	110	50

*Equalize and condition - target EMC

Southern Lowland Oak 4/4, 5/4, 6/4

Southern Lowland Oak 4/4, 5/4, 6/4
(Cons.)

% MC	DB Temp (°F)	WB Temp (°F)	DEP	% MC	DB Temp (°F)	WB Temp (°F)	DEP
GREEN - 40	100	97	3	GREEN - 40	95	92	3
40 - 35	100	96	4	40 - 35	97	93	4
35 - 30	100	92	8	35 - 30	100	94	6
30 - 25	110	100	10	30 - 25	108	100	8
25 - 20	120	95	25	25 - 20	118	98	20
20 - 15	130	80	50	20 - 15	130	90	40
15 - FINAL	150	100	50	15 - FINAL	150	100	50

*Equalize and condition - target EMC

Sugar Maple Sq. 4/4, 5/4, 6/4
(Hard, End Coated)

Sugar Maple Sq. 8/4
(Hard, End Coated)

% MC	DB Temp (°F)	WB Temp (°F)	DEP	% MC	DB Temp (°F)	WB Temp (°F)	DEP
GREEN - 40	120	111	9	GREEN - 40	120	115	5
40 - 35	125	110	15	40 - 35	120	111	9
35 - 30	135	113	22	35 - 30	125	109	16
30 - 25	145	107	38	30 - 25	135	107	28
25 - 20	155	110	45	25 - 20	150	104	46
20 - FINAL	160	110	50	20 - FINAL	160	110	50

*Equalize and condition - target EMC

Sugar Maple Sq. 12/4
(Hard, End Coated)

Sugar Maple Sq. 16/4
(Hard, End Coated)

% MC	DB Temp (°F)	WB Temp (°F)	DEP	% MC	DB Temp (°F)	WB Temp (°F)	DEP
GREEN - 35	110	107	3	GREEN - 35	110	107	3
35 - 30	110	105	5	35 - 30	110	105	5
30 - 25	120	112	8	30 - 25	120	112	8
25 - 20	125	110	15	25 - 20	125	110	15
20 - 15	145	107	38	20 - 15	145	107	38
15 - FINAL	160	110	50	15 - FINAL	160	110	50

*Equalize and condition - target EMC

Sugar Maple (Hard) 4/4, 5/4, 6/4**Sugar Maple (Hard) 8/4**

% MC	DB Temp (°F)	WB Temp (°F)	DEP	% MC	DB Temp (°F)	WB Temp (°F)	DEP
GREEN - 40	120	114	6	GREEN - 40	115	110	5
40 - 35	120	112	8	40 - 35	120	115	5
35 - 30	125	116	9	35 - 30	120	113	7
30 - 25	130	118	12	30 - 25	125	115	10
25 - 20	140	118	22	25 - 20	135	115	20
20 - 15	150	115	35	20 - 15	145	110	35
15 - FINAL	160	110	50	15 - FINAL	160	110	50

*Equalize and condition - target EMC

Sweetgum 12/4**Sycamore 4/4, 5/4, 6/4**

% MC	DB Temp (°F)	WB Temp (°F)	DEP	% MC	DB Temp (°F)	WB Temp (°F)	DEP
GREEN - 35	100	94	6	Green 50	120	116	4
35 - 30	110	104	6	50-40	120	115	5
30 - 25	120	110	10	40-35	120	112	8
25 - 20	130	114	16	35-30	120	106	14
20 - 15	145	115	30	30-25	120	100	20
15 - FINAL	160	115	45	25-20	140	90	50
				20-15	150	100	50
				15-6	155	120	35

Tamarack, Western Larch 4/4**Tamarack, Western Larch 8/4**

% MC	DB Temp (°F)	WB Temp (°F)	DEP	% MC	DB Temp (°F)	WB Temp (°F)	DEP
GREEN - 35	120	113	7	GREEN - 40	120	113	7
35 - 30	120	110	10	40 - 35	120	110	10
30 - 25	125	110	15	35 - 30	125	110	15
25 - 20	130	110	20	30 - 25	130	110	20
20 - 15	135	110	25	25 - 20	135	110	25
15 - FINAL	150	110	40	20 - 15	140	110	30
				15 - FINAL	150	110	40

Tanoak 4/4, 5/4**Teak 4/4, 5/4, 6/4**

% MC	DB Temp (°F)	WB Temp (°F)	DEP	% MC	DB Temp (°F)	WB Temp (°F)	DEP
GREEN - 40	100	96	4	GREEN - 50	120	113	7
40 - 35	105	101	4	50 - 40	120	110	10
35 - 30	110	105	5	40 - 35	120	105	15
30 - 25	120	108	12	35 - 30	120	95	25
25 - 20	130	105	25	30 - 25	130	90	40
20 - 15	140	90	50	25 - 20	140	90	50
15 - FINAL	160	110	50	20 - 15	150	100	50
				15 - FINAL	160	110	50

Teak 8/4

% MC	DB Temp (°F)	WB Temp (°F)	DEP
GREEN - 50	110	105	5
50 - 40	110	103	7
40 - 35	110	99	11
35 - 30	110	91	19
30 - 25	120	85	35
25 - 20	130	80	50
20 - 15	140	90	50
15 - FINAL	160	110	50

Teak 12/4

% MC	DB Temp (°F)	WB Temp (°F)	DEP
GREEN - 40	110	107	3
40 - 35	110	106	4
35 - 30	110	104	6
30 - 25	120	110	10
25 - 20	130	105	25
20 - 15	140	90	50
15 - FINAL	160	110	50

Tulip, Yellow Poplar 4/4, 5/4, 6/4

% MC	DB Temp (°F)	WB Temp (°F)	DEP
GREEN - 50	125	115	10
50 - 40	130	114	16
40 - 35	135	115	20
35 - 30	145	115	30
30 - 25	150	100	50
25 - FINAL	160	110	50

Tulip, Yellow Poplar 8/4

% MC	DB Temp (°F)	WB Temp (°F)	DEP
GREEN - 50	120	112	8
50 - 40	125	115	10
40 - 35	130	116	14
35 - 30	135	113	22
30 - 25	150	115	35
25 - FINAL	160	110	50

White Ash 4/4

% MC	DB Temp (°F)	WB Temp (°F)	DEP
GREEN - 35	110	103	7
35 - 30	110	101	9
30 - 25	120	105	15
25 - 20	130	105	25
20 - 15	140	105	35
15 - FINAL	150	105	45

White Birch 4/4

% MC	DB Temp (°F)	WB Temp (°F)	DEP
GREEN - 40	100	85	15
40 - 35	110	94	16
35 - 30	125	95	30
30 - 25	130	100	30
25 - 20	140	100	40
20 - 15	150	100	50
15 - FINAL	160	100	60

White Oak 4/4, 5/4, 6/4

% MC	DB Temp (°F)	WB Temp (°F)	DEP
GREEN - 40	110	106	4
40 - 35	110	105	5
35 - 30	110	102	8
30 - 25	120	106	14
25 - 20	130	100	30
20 - 15	140	90	50
15 - FINAL	160	110	50

White Oak 8/4

% MC	DB Temp (°F)	WB Temp (°F)	DEP
GREEN - 40	110	107	3
40 - 35	110	106	4
35 - 30	110	104	6
30 - 25	120	110	10
25 - 20	130	105	25
20 - 15	140	90	50
15 - FINAL	160	110	50

*Equalize and condition - target EMC

White Oak (Conservative Sch.) 4/4, 5/4**White Oak (Conservative Sch.) 6/4, 8/4**

% MC	DB Temp (°F)	WB Temp (°F)	DEP	% MC	DB Temp (°F)	WB Temp (°F)	DEP
GREEN - 40	100	96	4	GREEN - 40	100	97	3
40 - 35	105	101	4	40 - 35	100	96	4
35 - 30	110	105	5	35 - 30	105	99	6
30 - 25	120	108	12	30 - 25	115	107	8
25 - 20	130	105	25	25 - 20	125	100	25
20 - 15	140	90	50	20 - 15	140	90	50
15 - FINAL	160	110	50	15 - FINAL	160	110	50

*Equalize and condition - target EMC

White Walnut 4/4**Yellow Birch 4/4**

% MC	DB Temp (°F)	WB Temp (°F)	DEP	% MC	DB Temp (°F)	WB Temp (°F)	DEP
GREEN - 50	105	95	10	GREEN - 40	105	91	14
50 - 40	110	96	14	40 - 35	110	94	16
40 - 35	115	99	16	35 - 30	120	103	17
35 - 30	120	95	25	30 - 25	130	103	27
30 - 25	130	90	40	25 - 20	140	110	30
25 - 20	140	115	25	20 - 15	150	115	35
20 - 15	150	115	35	15 - FINAL	160	115	45
15 - FINAL	160	115	45				

Drying Rates - North American Measure

Species	Oven Dry Weight #/MBF	Avg. Green MC %	Green Weight #/MBF	# Water Per % MC	Max MC% Loss/ day
Cedar, Eastern White	1578	93	3046	16	11
Fir, Balsam	1739	118	3790	17	20
Hemlock, Eastern	2161	111	4558	22	20
Larch, Eastern	2532	52	3849	25	20
Pine, Red (Norway)	2051	83	3747	21	15
Pine, Eastern White	1950	90	3705	20	12
Spruce, Black	2110	80	3798	21	20
Spruce, Red	2000	89	3781	20	20
Spruce, White	1840	115	3967	18	20
Ash, Black	2532	95	4937	25	7
Ash, White	3055	45	4431	31	10.4
Basswood	1899	107	3933	19	12
Beech	3114	63	5089	31	4.5
Birch, White	2692	73	4659	27	10
Birch, Yellow	2954	69	4996	30	6.1
Cherry, Black	2633	58	4161	26	5.8
Elm, Rock	3165	50	4760	32	3.5
Elm, White	2692	93	5207	27	10.4
Hickory	3325	64	5452	33	6
Maple, Soft	2692	93	4389	27	13.8
Maple, Hard	3165	68	5317	32	6.5
Oak, Northern Red Upland	3277	74	5703	33	3.8
Oak, White Upland	3518	70	5981	35	2.5
Oak, Southern Red	3092	80	5567	31	3.8
Sweetgum (Red gum)	2740	100	5480	27	5.3
Walnut	2851	85	5274	29	8.2
Yellow Poplar, Cottonwood	1899	154	4819	19	13.8

Northeast Lumber - Based on 4/4 (1" or 25 mm)

To estimate maximum % MC loss per day for other thickness' multiply % MC loss per day from the above table by 0.6 for 6/4 and 0.4 for 8/4.

Drying Rates - Metric

Species	Oven Dry Weight Kg / M3	Avg. Green MC %	Green Weight Kg / M3	Kg Water Per % MC	Max MC% Loss/day
Cedar, Eastern White	315.6	93	609.2	7.27	11
Fir, Balsam	347.8	118	758	7.73	20
Hemlock, Eastern	432.2	111	911.6	10	20
Larch, Eastern	506.4	52	769.8	11.36	20
Pine, Red (Norway)	410.2	83	749.4	9.55	15
Pine, Eastern White	390	90	741	9.09	12
Spruce, Black	422	80	759.6	9.55	20
Spruce, Red	400	89	756.2	9.09	20
Spruce, White	368	115	793.4	8.18	20
Ash, Black	506.4	95	987.4	11.36	7
Ash, White	611	45	886.2	14.09	10.4
Basswood	379.8	107	786.6	8.64	12
Beech	622.8	63	1017.8	14.09	4.5
Birch, White	538.4	73	931.8	12.27	10
Birch, Yellow	590.8	69	999.2	13.64	6.1
Cherry, Black	526.6	58	832.2	11.82	5.8
Elm, Rock	633	50	952	14.55	3.5
Elm, White	538.4	93	1041.4	12.27	10
Hickory	655	64	1090.4	15	6
Maple, Soft	538.4	93	877.8	12.27	13.8
Maple, Hard	633	68	1063.4	14.55	6.5
Oak, Northern Red Upland	655.4	74	1140.6	15	3.8
Oak, White Upland	703.6	70	1196.2	15.91	2.5
Oak, Southern Red	618.4	80	1113.4	14.09	2
Sweetgum (Red gum)	548	100	1096	12.27	5.3
Walnut	570.2	85	1054.8	13.18	8.2
Yellow Poplar, Cottonwood	379.8	154	963.8	8.64	13.8

Northeast Lumber - Based on 4/4 (1" or 25 mm)

To estimate maximum % MC loss per day for other thickness' multiply % MC loss per day from the above table by 0.6 for 6/4 and 0.4 for 8/4.

Nyle Drying Chart

Wet Bulb Depression [Dry Bulb - Wet Bulb] °F

Dry Bulb °F	Measurement	2°	4°	6°	8°	10°	12°	14°	16°	18°	20°	25°	30°	35°	40°	45°	50°	
30°	RH	78.0	57.0	36.0	17.0													
	EMC	15.9	10.8	7.4	3.9													
	DRI	0.0	0.1	0.1	0.1													
35°	RH	81.0	63.0	45.0	28.0	11.0												
	EMC	16.8	11.9	8.8	6.0	2.9												
	DRI	0.0	0.1	0.1	0.1	0.2												
40°	RH	83.0	68.0	52.0	37.0	22.0	8.0											
	EMC	17.6	12.9	9.9	7.4	5.0	1.9											
	DRI	0.0	0.1	0.1	0.2	0.2	0.2											
45°	RH	85.0	72.0	58.0	44.0	31.0	19.0	6.0										
	EMC	18.3	13.7	10.7	8.5	6.5	4.2	1.5										
	DRI	0.0	0.1	0.1	0.2	0.2	0.2	0.3										
50°	RH	86.0	74.0	62.0	50.0	38.0	27.0	16.0	5.0									
	EMC	19.0	14.4	11.5	9.4	7.6	5.7	3.9	1.5									
	DRI	0.1	0.1	0.1	0.2	0.2	0.3	0.3	0.3									
55°	RH	88.0	76.0	65.0	54.0	44.0	34.0	24.0	14.0	5.0								
	EMC	19.5	15.1	12.2	10.1	8.4	6.8	7.3	3.6	1.3								
	DRI	0.1	0.1	0.2	0.2	0.2	0.3	0.3	0.4	0.4								
60°	RH	89.0	78.0	68.0	58.0	48.0	39.0	30.0	21.0	13.0	5.0							
	EMC	19.9	15.6	12.7	10.7	9.1	7.6	6.3	4.9	3.2	1.3							
	DRI	0.1	0.1	0.2	0.2	0.3	0.3	0.4	0.5	0.5	0.5							
65°	RH	90.0	80.0	70.0	61.0	52.0	44.0	36.0	27.0	20.0	13.0							
	EMC	20.3	16.1	13.3	11.2	9.7	8.3	7.1	5.8	4.5	3.0							
	DRI	0.1	0.1	0.2	0.2	0.3	0.3	0.4	0.5	0.5	0.5							
70°	RH	90.0	81.0	72.0	64.0	55.0	48.0	40.0	33.0	25.0	19.0	3.0						
	EMC	20.6	16.5	13.2	11.6	10.1	8.8	7.7	6.6	5.5	4.3	0.7						
	DRI	0.1	0.1	0.2	0.3	0.3	0.4	0.4	0.5	0.6	0.6	0.7						
75°	RH	91.0	82.0	74.0	66.0	58.0	51.0	44.0	37.0	31.0	24.0	10.0						
	EMC	20.6	16.8	14.0	12.0	10.5	9.3	8.2	7.2	6.2	5.1	2.3						
	DRI	0.1	0.2	0.2	0.3	0.4	0.4	0.5	0.6	0.6	0.7	0.8						
80°	RH	91.0	83.0	75.0	68.0	61.0	54.0	47.0	41.0	35.0	29.0	15.0	3.0					
	EMC	21.0	17.0	14.3	12.3	10.9	9.7	8.6	7.7	6.8	5.8	3.5	0.3					
	DRI	0.1	0.2	0.3	0.3	0.4	0.5	0.5	0.6	0.7	0.7	0.9	1.0					
85°	RH	92.0	84.0	76.0	70.0	63.0	56.0	50.0	44.0	38.0	33.0	20.0	9.0					
	EMC	21.2	17.2	14.5	12.5	11.2	10.0	9.0	8.1	7.2	6.3	4.3	1.7					
	DRI	0.1	0.2	0.3	0.4	0.4	0.5	0.6	0.7	0.8	0.8	1.0	1.1					
90°	RH	92.0	85.0	78.0	71.0	65.0	58.0	52.0	47.0	41.0	36.0	24.0	13.0	3.0				
	EMC	21.3	17.3	14.7	12.8	11.4	10.2	9.3	8.4	7.6	6.8	4.9	2.8	0.9				
	DRI	0.1	0.2	0.3	0.4	0.5	0.6	0.7	0.8	0.8	0.9	1.1	1.2	1.4				
95°	RH	92.0	85.0	79.0	72.0	66.0	60.0	55.0	49.0	44.0	39.0	28.0	17.0	8.0				
	EMC	21.3	17.4	14.9	12.9	11.6	10.5	9.5	8.7	7.9	7.1	5.3	3.6	1.9				
	DRI	0.1	0.2	0.3	0.5	0.6	0.7	0.7	0.8	0.9	1.0	1.2	1.4	1.5				
100°	RH	93.0	86.0	80.0	73.0	68.0	62.0	56.0	51.0	46.0	41.0	30.0	21.0	12.0	4.0			
	EMC	21.3	17.5	15.0	13.1	11.8	10.6	9.6	8.9	8.1	7.4	5.7	4.2	2.8	0.7			
	DRI	0.1	0.3	0.4	0.5	0.6	0.7	0.9	0.9	0.9	1.1	1.4	1.5	1.7	1.9			

DryBulb °F	2°	4°	6°	8°	10°	12°	14°	16°	18°	20°	25°	30°	35°	40°	45°	50°
105°	RH	93.0	87.0	80.0	74.0	69.0	63.0	58.0	53.0	48.0	44.0	34.0	24.0	16.0	8.0	
	EMC	21.4	17.5	15.1	13.2	11.9	10.8	9.8	9.0	8.3	7.6	6.1	4.6	3.3	1.8	
	DRI	0.2	0.3	0.4	0.6	0.7	0.8	0.9	1.1	1.2	1.3	1.5	1.7	1.9	2.1	
110°	RH	93.0	87.0	81.0	75.0	70.0	65.0	60.0	55.0	50.0	46.0	36.0	26.0	19.0	11.0	4.0
	EMC	21.4	17.5	15.1	13.3	12.0	10.8	9.9	9.2	8.4	7.7	6.3	4.8	3.8	2.5	1.1
	DRI	0.2	0.3	0.5	0.6	0.8	0.9	1.0	1.2	1.3	1.4	1.7	1.9	2.1	2.3	2.5
115°	RH	93.0	88.0	82.0	76.0	71.0	66.0	61.0	56.0	52.0	48.0	38.0	22.0	14.0	8.0	2.0
	EMC	21.4	17.5	15.1	13.4	12.1	10.9	10.0	9.3	8.6	7.8	6.5	5.2	4.1	2.9	0.4
	DRI	0.2	0.4	0.5	0.7	0.9	1.0	1.1	1.2	1.3	1.4	1.6	1.9	2.1	2.4	2.8
120°	RH	94.0	88.0	82.0	77.0	72.0	67.0	62.0	58.0	53.0	49.0	40.0	31.0	24.0	17.0	10.0
	EMC	21.3	17.4	15.1	13.4	12.1	11.0	10.0	9.4	8.7	7.9	6.6	5.4	4.4	3.3	2.3
	DRI	0.2	0.4	0.6	0.8	1.0	1.1	1.3	1.5	1.6	1.8	2.1	2.4	2.6	2.9	3.1
125°	RH	94.0	88.0	83.0	77.0	73.0	68.0	63.0	59.0	55.0	51.0	41.0	33.0	26.0	19.0	13.0
	EMC	21.2	17.3	15.0	13.4	12.1	11.0	10.0	9.4	8.7	8.0	6.7	5.5	4.6	3.6	2.7
	DRI	0.2	0.5	0.7	0.9	1.1	1.3	1.5	1.6	1.8	1.9	2.3	2.7	2.9	3.2	3.4
130°	RH	94.0	89.0	83.0	78.0	73.0	69.0	64.0	60.0	56.0	52.0	43.0	35.0	28.0	21.0	15.0
	EMC	21.0	18.2	14.9	13.4	12.1	11.0	10.0	9.4	8.7	8.0	6.8	5.6	4.8	3.8	3.0
	DRI	0.3	0.5	0.8	1.0	1.1	1.4	1.6	1.8	2.0	2.2	2.6	2.9	3.3	3.6	3.9
140°	RH	95.0	89.0	84.0	79.0	75.0	70.0	66.0	62.0	58.0	54.0	46.0	38.0	31.0	25.0	19.0
	EMC	1.0	16.9	14.8	13.2	11.9	10.6	10.0	9.4	8.7	8.0	6.9	5.8	5.0	4.1	3.4
	DRI	0.3	0.6	0.9	1.2	1.5	1.8	2.0	2.2	2.5	2.7	3.2	3.7	4.1	4.4	4.8
150°	RH	95.0	90.0	85.0	80.0	76.0	72.0	68.0	64.0	60.0	57.0	48.0	41.0	35.0	28.0	23.0
	EMC	20.2	16.9	14.5	13.0	11.8	10.8	9.9	9.2	8.6	8.0	6.9	5.8	5.1	4.2	3.6
	DRI	0.4	0.8	1.1	1.5	1.8	2.1	2.4	2.7	3.0	3.3	3.9	4.5	5.0	5.5	5.8
160°	RH	95.0	90.0	86.0	81.0	77.0	73.0	69.0	65.0	62.0	58.0	50.0	43.0	37.0	31.0	25.0
	EMC	19.8	16.2	14.2	12.7	11.5	10.6	9.7	9.1	8.5	7.9	6.8	5.8	5.1	4.3	3.7
	DRI	0.5	1.0	1.4	1.8	2.2	2.6	3.0	3.4	3.7	4.1	4.8	5.5	6.1	6.7	7.2
170°	RH	95.0	91.0	86.0	82.0	78.0	74.0	70.0	67.0	63.0	60.0	52.0	45.0	39.0	33.0	28.0
	EMC	19.4	15.8	13.9	12.4	11.3	10.4	9.6	9.0	8.4	7.8	6.7	5.7	5.1	4.4	3.7
	DRI	0.6	1.1	1.7	2.2	2.7	3.2	3.7	4.0	4.5	4.9	5.9	6.7	7.5	8.2	8.8
180°	RH	96.0	91.0	87.0	83.0	79.0	75.0	72.0	68.0	65.0	62.0	54.0	47.0	41.0	35.0	30.0
	EMC	18.9	15.5	13.7	12.2	11.1	10.1	9.4	8.8	8.1	7.6	6.5	5.7	5.1	4.4	3.8
	DRI	0.6	1.4	2.0	2.6	3.2	3.8	4.3	4.9	5.4	5.8	7.0	8.1	9.0	10.0	10.7
190°	RH	96.0	92.0	88.0	84.0	80.0	76.0	73.0	69.0	66.0	63.0	56.0	49.0	43.0	37.0	32.0
	EMC	18.5	15.2	13.4	12.0	10.9	10.0	9.2	8.6	7.9	7.4	6.4	5.5	4.9	4.4	3.8
	DRI	0.8	1.5	2.3	3.0	3.8	4.6	5.1	5.9	6.5	7.0	8.4	9.7	10.9	12.0	12.9
200°	RH	96.0	92.0	88.0	84.0	80.0	77.0	84.0	80.0	77.0	74.0	64.0	57.0	45.0	39.0	34.0
	EMC	18.1	14.9	13.2	11.8	10.8	9.8	9.1	8.4	7.7	7.2	6.2	5.4	4.8	4.3	3.8
	DRI	0.9	1.9	2.8	3.8	4.7	5.4	6.1	7.0	7.8	8.5	10.1	11.5	13.0	14.3	15.5
210°	RH	96.0	92.0	88.0	85.0	81.0	78.0	75.0	71.0	68.0	65.0	59.0	52.0	46.0	41.0	36.0
	EMC	17.7	14.6	13.0	11.7	10.6	9.7	9.0	8.3	7.6	7.1	6.1	5.3	4.7	4.2	3.7
	DRI	1.2	2.3	3.5	4.3	5.5	6.3	7.2	8.3	9.2	10.1	11.8	16.8	15.5	17.0	18.4

Kiln Sample Boards

To measure moisture content on a daily basis, it is best to use sample boards. Moisture meters are not accurate enough for most hardwood dry kiln operations when the wood is above 30% MC and there is a need to keep a close watch on the drying rate. In Oak, for example, all checks and honeycombing occur when the wood is drying from green down to 40% MC, so that is when the drying rate needs to be closely controlled.

Uses for Sample Boards

- To estimate the MC of the load in the chamber, so that kiln conditions can be regulated according to drying schedules.
- To measure the drying rate, which allows control of drying quality.
- To check on any degrade development.
- To check on final MC and drying stresses.
- To develop a MC vs. time curve.
- To study variations in drying within the kiln.
- To monitor changes in MC after drying (during storage and shipping) Note: It is a good idea to keep sample boards with dried lumber so that they can be used to track moisture content changes in storage.

Taking Samples

1. Select sample boards. Keep in mind that they need to represent a "sample" of the lumber in the kiln. Do not select junk boards, and select both the slowest and the fastest drying boards of the load. Generally, you want six sample boards.
2. Cut 30" samples, at least 12" from the ends of each of the sample boards. Avoid having knots, splinters or bark in the sample.
3. Number the samples you cut.
4. Cut two 1" sections off each end of the samples, and mark them with the number of the board they came from.

Example: the two sections that came from sample board 3 would be labeled 3A and 3B.

5. Apply end coat the now 28" sample boards. This assures that the sample board will dry as though it were a larger piece of lumber.

End coatings are not usually required when lumber is placed in the kiln directly after being sawn. However when lumber is air dried prior to kiln drying, end coating is often helpful in preventing end checks

6. Weigh the 28" sample boards. An accuracy of .025 pounds or 1 gram is recommended. Record these values.
7. Put the 28" sample boards in the lumber stacks in places where they can be reached and will dry at the same rate as the lumber. Do not place the sample boards where they will receive more air flow than the rest of the lumber.
8. Take the "green weight" by weighing all the 1" sections, to 0.1 gram accuracy is suggested. Record these values.
9. Oven dry the 1" sections using one of the two methods below.
 - Microwave: with carousel tray: Put sections on a paper towel on the tray. Use low power (to avoid smoking) for 20 minutes. Weigh the section, and put back in the oven for 1 minute. If the section has not lost any weight, it is oven dry. If still losing water, continue drying in 5 minute increments until a constant weight is achieved.
 - Oven: Place the 1" section in an oven at 215°F (101°C) until the section stops losing weight, usually takes 24 hours. Check hourly until the section weighs the same in separate weighings.
10. Calculate the moisture content of each 1" section separately using the following formula:

$$\%MC = \left(\frac{\text{Wet Weight}}{\text{Oven Dry Weight}} - 1 \right) \times 100$$

11. Average the moisture content of the two 1" sections from each 28" sample board to calculate the estimated moisture content of the sample board when it was cut.
12. Calculate the oven dry weight of the 28" sample board is using the following formula and the average moisture content (MC) from the previous step:

$$\text{OD weight} = \left(\frac{\text{Wet Weight}}{100 + \%MC} \right) \times 100$$

13. Write the calculated OD weight on the sample board so that it is readily available.
14. At about the same time each day, weigh the sample boards and calculate the current moisture content with this formula:

$$\text{Current \%MC} = \left(\frac{\text{Current Weight}}{\text{Calculated Oven Dry Weight}} - 1 \right) \times 100$$

15. Place the 28" sample board back in the same place in the kiln it came from.
16. Calculate the daily drying rate for each section. Keep all the figures written down as a record of the load. Make any adjustments to the schedule based on the fastest drying sample.
17. Once the moisture content of the kiln is below 20%, it is often a good idea to cut new 1" sections from the center of the sample boards (1 section per board).

Example: Two 1" sections are cut from 30" sample board 1, and labeled 1A and 1B. They are weighed on a balance, and the weights are: A=2.5g and B=2.3g. The sections are placed in a microwave on low power for 20 minutes and weighed, weighing A=1.7g and B=1.6g. They are put back in the microwave for 1 minute and weighed again. The weights did not change, so these values are now oven dry weights.

- Calculate the moisture content using the formula in step 10.

$$A = [(2.5 / 1.7) - 1] \times 100 = 47.06 \quad B = [(2.3 / 1.6) - 1] \times 100 = 43.75$$

- Average the two calculations together:
(47.06 + 43.75) / 2 = 45.40%.

This is the calculated moisture content for the rest of the sample board.

- Calculate the oven dry weight of the sample board 1. Use the formula in step 11. The green weight is 1.64 kilograms.

$$\text{ODW} = (1.64 / 145.4) \times 100 = 1.13 \text{ kg.}$$

- After a day in the kiln, weigh sample board 1 and it weights 1.58 kg. Using the formula in step 13, the moisture content is:

$$\%MC = [(1.58 / 1.13) - 1] \times 100 = 39.8$$

- The daily change in moisture content is:
45.4 - 39.8 = 5.6%.

Record Keeping

A good system of record keeping for the dry kiln is essential to developing a good operating procedure. The records that are kept will indicate when operations are deviating from the norm and will allow future schedules to alter to improve production.

It is recommended that all information be kept on the sample boards as outlined in the Dry Kiln Operator's Manual. It is suggested that the Nyle Kiln record form be used. If properly used it will provide ample data to judge kiln performance and schedule adjustments.

In addition to the records kept daily on the sample boards, it is also very important to plot on a graph the average and wettest drying sample. If possible, plot all the samples on the graph. This will indicate the drying rate and often any adjustment will become apparent on the graph before it is analyzed in the data.

Each day, the water removal should be weighed for one minute and that figure recorded on the kiln records. While one direct use is made of this information in the drying schedule, a deviation from normally expected water flows will give early warning of a malfunction in the refrigeration system.

Several times during the cycle the bulb should be measured on both sides of the load and in several areas. The average should be noted on the kiln record. As with measuring the water removal rate, this is not used in the operation of the kiln but deviations from normal will indicate a problem in loading, baffling, airflow etc. That will affect drying. These figures will always vary but being familiar with them, the operator will be able to detect a malfunction early.

Record should be kept for comparison throughout the year. It is wise to compare summer loads with summer and winter loads.

Drying Rate Index (DRI)

The dry kiln industry has never had a method of predicting drying rates. This is remarkable as one main reason for having a kiln is to bring about predictable production rates. The EMC value gives an end point of what the moisture content of the lumber would eventually become but it does not give an indication of how long it will take to reach that moisture content.

Drying schedules for dehumidification drying were developed in the late 1970's. It became obvious that a method of adjusting kiln schedules to meet drying time objectives within the limitations of the operation range of the dehumidifiers had to be found. It was common to look up a drying schedule in the Dry Kiln Operators Manual or some other reference, and then find a set of conditions at which dehumidifier could run using the same EMC. This resulted in unnecessarily long drying cycles and was quickly shown to be an ineffective method of doing kiln schedules.

Nyle developed the Drying Rate Index in response to that but time has shown that the Drying Rate Index is very useful in both conventional and dehumidification kilns. With the trend to control kilns by monitoring drying rate to get maximum productivity and quality, the Drying Index becomes a very valuable tool.

The drying rate is a function of the vapor pressure deficit. Everyone knows that things dry faster in hotter, drier air. Every fluid has a vapor pressure associated with it that varies with the temperature of the fluid. Air has a vapor pressure that is of function of temperature and humidity. The difference between the two determines the rate drying. This is how everything in the world dries whether it is paint, the ocean, the lumber or perspiration. When the humidity of the air is 100% no evaporation takes place regardless of the temperature. As relative humidity drops the rate the fluid evaporates increases. The problem is that a way of predicting the change in drying rate with changes in temperature and humidity was needed.

The Drying Rate Index is a relative number. For example: A kiln is operating at 120° F. dry bulb and 110° F. wet bulb, that means the depression is:

10° (120° F.- 110° F. = 10° F.) According to the Nyle Drying Chart, The relative humidity is 72% the Equilibrium Moisture Content (EMC) is 12.1% and the Drying Rate Index (DRI) is 1.0. The EMC indicates where the lumber will end eventually. The EMC is also an indication of where the surface moisture content of the lumber will go fairly quickly. The whole board will eventually be 12.1 % but the surface will reach 12.1% much quicker.

In the above example, the lumber might be drying at 3% per day but it could be dried faster at 5% per day. In order to change the drying rate from 3% per

day to 5% per day, it would be necessary to find a DRI that is 1.67 times the existing drying rate.

Desired Drying Rate/Existing Drying Rate = Multiplier.
(5/3=1.67)

Multiplier x Existing DRI= Desired DRI

The existing DRI is 0.9 so the new DRI should be 1.5
(0.9 x 1.67)

Referring to the Nyle Drying Chart (Pg 32), it can be seen that if the temperature were increased to 130° F and the depression 13° F (read between 12 and 14 on the chart), the DRI will be 1.5. Other combinations of dry bulb and depression will give the same result. For example dry bulb could be left at 120° F and the depression increased to 17° F, or the dry bulb could be raised to 140° F. and the depression left at 10° F. All of these would result in a 1.5 DRI and thus would dry the lumber at 5% per day.

Note: that in the above three choices, 130/13, 120/17 and 140/10, the EMC is 10.5, 9.1 and 11.9 respectively. It is clear that EMC has nothing to do with how fast lumber dries but it does mean that low temperatures and bigger depressions may mean the surface moisture content will be lower. In some cases, were this pressed to an extreme, it may make the surface shrink too much so that factor should be considered.

The best way to use the drying chart is to check the kiln each day. Calculate the moisture loss and then adjust the kiln temperature and humidity each day to achieve the drying rate desired. Each charge of lumber will be different and will result in a different drying schedule. For this reason, it will be clear that drying schedules are of little use except as a starting point. None of the drying schedule published state at what airflow they were developed. So running a schedule from a manual or another operation is ineffective as the airflow in the kiln may be different and may change through the cycle if variable speed fans are used.

Drying Tips

- Fresh cut lumber dries better and is less likely to be damaged during the drying process. Try to get it in the kiln as soon as possible.
- If you can't dry your lumber immediately after its been cut make sure that it is stacked, stickered and stored in a clean, dry place. Monitor it until it is ready to be put in the kiln as its moisture content will change during this time.

- Carefully plan your drying schedules for every batch of lumber and follow through with them, only making alterations when necessary. Neglecting an effective schedule can ruin product and cost you money.
- Air flowing through the lumber will be removing the moisture. Make sure you take the time to properly sticker and stack your lumber in the kiln. Better airflow will result in better drying.
- Use baffles and deflectors to control airflow inside the kiln when drying, it will be more efficient and result in more evenly dried lumber.
- Keep detailed records of every batch. If necessary you can use them as a reference when making improvements in scheduling or correcting mistakes.
- Make sure that an operator is always available when drying so that any necessary adjustments can be made as soon as possible. This will reduce the chance of any major issues during the process.
- Always double check your numbers at the end of a schedule to make sure that you have achieved your desired result.
- Every detail is important when drying lumber. Make sure that you are following operation and safety guidelines. Cutting corners can ruin your product, damage your unit, or even cause injury.
- If you are unsure about any aspect of operation or if something seems to be working incorrectly please contact Nyle as soon as possible. Do not continue operation, attempt any adjustment or repair to a unit with out consulting a licensed professional.
- Once a batch of lumber is dried keep it in a clean, dry location, away from the elements. Ideally kept inside and off the ground.
- Always stay up to date with the latest information on lumber drying. Attend trainings and seminars whenever possible and keep in contact with your local forestry offices

Spray Systems Kits

Although not standard on Nyle DH Kilns you may choose to add on this optional Spray System Kit which will provide extra control when drying. The Sprayers are designed to be automatically activated by the system when needed and help with regulating the relative humidity within the kiln chamber.

Nyle spray systems are designed to inject into kiln air one gallon of water per hour for every 1000 BF. Because air temperature affects the quantity of water evaporated (warmer air holds more water vapor), we need to balance the quantity of water vapor to the kiln capacity. DH units with small heaters will require proportionately less water than larger units with bigger heating capacity. There are options available for every unit so be sure that the kit you are purchasing matches the specifications for the unit that it will be installed in.

Nyle encourages boosting water pressure to 100 psi for the spray system to have the best results. Commonly this is done with the use of a jet pump, which can be purchased through Nyle if requested. Contact your Nyle Sales or Service Representative for more information.

CONTROL ROOM ASSEMBLY OF SOLENOID VALVE, STRAINER, AND REGULATOR

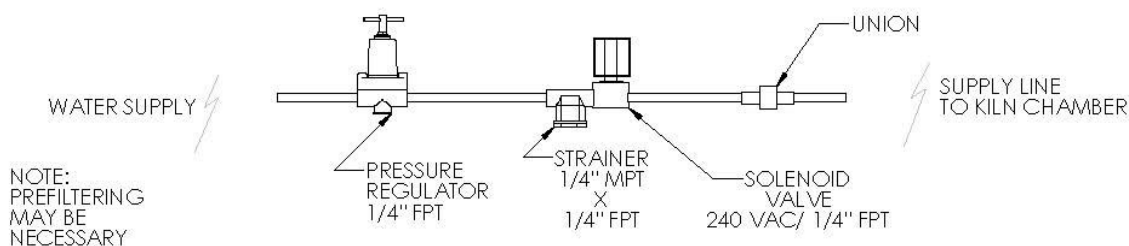

LOCATE SUPPLY LINE IN A CONVENIENT LOCATION

ELECTICAL CONNECTIONS:
WIRE THE SOLENOID VALVE BACK TO NYLE ELECTRICAL
PANEL AND CONNECT TO TB1 [16] AND [N]

Maintenance

General Maintenance for HT-Series

The HT-Series is designed for continuous duty, with little maintenance. However, when a problem does arise prompt repair will ensure long life for the machine.

The blower system is direct drive and the motor has sealed high temperature ball bearings. This unit does not need regular maintenance.

The air filter should be washed when dirty and replaced when necessary. If the filter becomes clogged, the air supply will be drastically reduced, causing the heater to overheat and the refrigeration system to overload. Evap coil should be kept clean. Clean with dish soap and water.

The refrigeration system is a sealed system with its own oil supply. Again regular maintenance is not required. However, if the system is not removing the normal amount of water at the appropriate conditions, the refrigeration system should be looked at by a reputable refrigeration mechanic. When the system experiences reduced water output, this is generally associated with a leak in the refrigeration system. If the leak is found and repaired before the system is empty, there is little chance that the system will be contaminated with moisture. If the system is ignored for a long period of time, moisture can enter the system and combine with the refrigerant to form acid. The system will then corrode from the inside-out if not corrected properly.

The circulating fan system is also direct drive with a ball bearing motor. The motor does not require lubrication.

Suggested Maintenance Schedule

After Each Charge:

1. Check air filters.
2. Visual Inspection of unit.
3. Replace wet bulb wick or sleeve.

Bimonthly:

Visual Inspection

1. Blower Assembly
2. Blower Belts
3. Electrical Panel Interior
4. Damper Assembly
5. Inspect Electrical Heater Terminals

Physical Maintenance

1. Lubricate Exhaust Dampers and Linkages*
2. Lubricate Evaporator Dampers and Linkages*
*Lubricate with **Loctite LB8014 anti-seizer**

Every Four Months

1. Grease Blower Assembly
2. Grease Circulating Fan Assembly
3. Grease Blower Motor
4. Clean Drain Lines and Pan

Air Inlet Filter Maintenance

The air filters are provided to keep the air inside the XDH unit as clean as possible. Dirt build-up on the coils will lead to poor heat transfer with loss of capacity. In extreme cases, the coil will completely clog. The supplied filter is washable and should be replaced when light can no longer shine through it after cleaning.

If the coils need to be cleaned, they can be sprayed with a garden hose using moderate pressure, because the fins are very fragile. Coils should be sprayed opposite the air flow, i.e., from back side to dislodge any material.

Blower System Maintenance

This system should be serviced **every 4-6 months**.

The system should be checked for:

1. Worn blower shaft bearings.
2. Loose, tight, or worn belts.
3. Loose drive and driven sheaves.
4. Loose bearing and motor mount belts.

The blower shaft bearings require 2 pumps of high quality, high temperature grease

It is very important that the belt tension is correct. If too tight, reduce bearing and belt life will result. If too loose, belt life will be shortened due to slippage. The ideal situation would be for the belts to be as loose as possible without squealing.

Correct tension is: ½" deflection at mid span with a force of 5 to 8 pounds.

Belt tension should be checked after the first few days of high temperature (130° - 160°F) operation due to initial belt stretch.

Always change belts in pairs because a new belt will always do more work than a stretch used belt, ruining the new belt.

Belts should never bottom in the groove of the sheave. This is a sign of over tightening. Belts get their grip from the sides. If it bottoms, this grip goes away, and no amount of tightening will return the grip.

Never stretch the belt over the pulleys, as this will break the inner cords. Always reduce the center distance when replacing belts. Install belt on the smaller pulley first.

Lubricating Ball Bearing Motors

Note: No lubrication is needed before startup as the bearings are lubricated at the manufacturing facility.

Lubrication Schedule

Service and Conditions	HP Range	Suggested Schedule
Minimal Use 5,000 Hrs or less	1/8 to 7 1/2	5 years
	10 - 40	3 years
	50 - 150	1 year
Seasonal Use 6 months or less	All	At the start of every season
Continuous Use Normal conditions	1/8 to 7 1/2	1 year
	10 - 40	1 year
	50 - 150	9 months
Continuous Use Harsh conditions	1/8 - 40	6 months
	50 - 150	3 months

Use high quality ball bearing grease. Use consistency of grease suitable for class of insulation stamped on nameplate as follows:

- On motors equipped with a grease fitting, clean tip of fitting and apply grease gun.
- Use 1 to 2 full strokes on motors in NEMA 215 frame and smaller.
- Use 2 to 3 strokes on NEMA 254 through NEMA 365 frame.
- Use 3 to 4 strokes on NEMA 404 frames and larger.

CAUTION: Keep grease clean. Lubricate motors at standstill. Remove and replace drain plugs at standstill. Do not mix petroleum grease and silicone grease in motor bearings.

Class	Consistency	Type	Typical Grease	Frame Type
A & B	#2	Lithium Base	Shell Alvania	215T or smaller
A & B	Medium	Polyurea	Shell Dolium R	254 or larger
F & H	Medium	Polyurea	Shell Dolium R	All

Fan Motor Lubrication Points

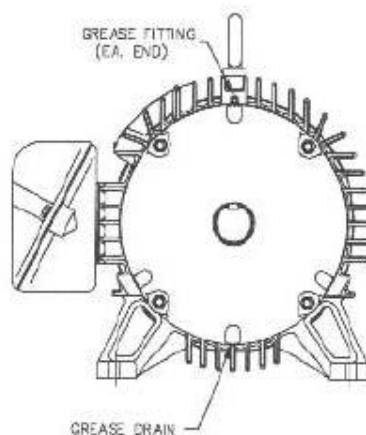
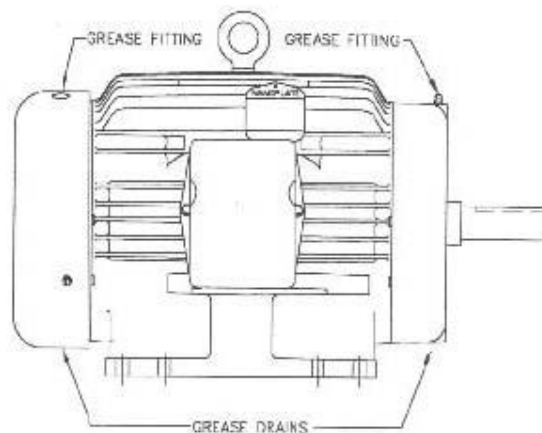

Refrigeration System Information

The refrigeration system is a closed loop system with its own lubrication oil supply. Nyle uses only the best trade practices when assembling these systems. The system should give years of trouble free service. However, if the system is not removing the right amount of water, or if a problem should arise from rough shipping or a refrigeration leak, the system should only be worked on by a qualified refrigeration mechanic.

Warning: Refrigeration professionals should use caution, these refrigeration conditions are uncommon.

These systems operate over a very wide temperature and humidity range. The pressures will be relatively high when compared to air conditioners and heat pumps. For these reasons, you cannot charge by the sight glass, the sight glass will eventually clear at certain conditions but it is unlikely that those conditions will exist when servicing.

If the kiln is loaded with lumber, it will be very dangerous to run the kiln at extreme limits, as the lumber will degrade severely. With this danger factor and the factor of time involved of heating the kiln, Nyle insists that these machines have weighed in charge. The amount is as follows:

HT-Series

HT4 (L300) - 10lbs. R-416 (FR-12)

HT8 (L500) - 12lbs. R-416 (FR-12)

HT16 (L1200S) - 25lbs. R-416 (FR-12)

HT35 - 60lbs. R-416 (FR-12)

HT42 - 60lbs. R-416 (FR-12)

HT54 - 75lbs. R-416 (FR-12)

HT70 - 120lbs. R-416 (FR-12)

HT84 - 120lbs. R-416 (FR-12)

HT108 - 150lbs. R-416 (FR-12)

HT162 - 225lbs. R-416 (FR-12)

Call nyle if your technician lacks the recommended refrigerant. We can recommend alternatives.

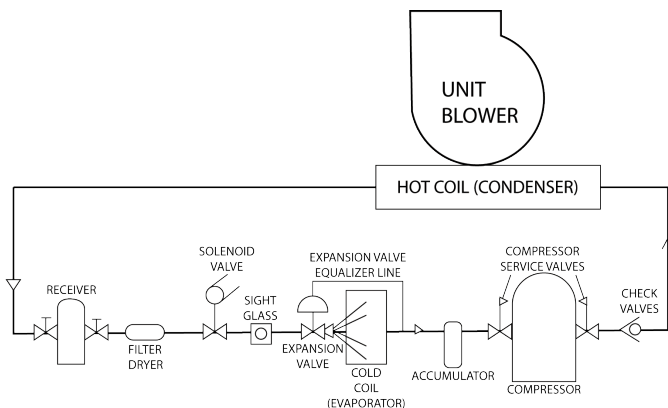

Refrigerant Charging Procedure

WARNING: This procedure is extremely dangerous and should only be performed by a certified HVAC Technician. Failure to comply could result in significant property damage, serious injury and even death.

The proper refrigerant charge is essential for efficient of the NYLE Lumber Drying System. The charging procedure outlined below will result in optimum performance.

Because the load and operating conditions vary more widely in a dry kiln than any other type of refrigeration system, normal procedures followed in the refrigeration and air conditioning industry cannot be used for charging the system.

At the extremes of high and low temperature, the following criteria must be met:

1. At high temperatures (160° F. dry bulb, 120° F. wet bulb) adequate sub cooling must be present in the suction gas to cool the motor windings.
2. At high temperatures, the discharge gas pressure must not exceed 375 PSIG.
3. At High temperatures, the actual discharge gas temperature must not exceed 260° F.
4. At low temperatures, prevent excessive liquid flood back.

Nyle suggests that the refrigerant charge be adjusted at maximum operating conditions (160° F dry bulb, 120° F. wet bulb). Do not allow the system to exceed the maximum temperature limits. Do not run the compressor when kiln temperatures are below 70° F.

These conditions should be simulated if the kiln is empty by operating the heaters and humidifier. If the kiln is loaded, it may not be possible to accurately adjust the charge until maximum conditions are reached at the end of the cycle. If an approximate charge is put in the system, it is imperative the refrigeration technician return when conditions are at the extreme. If the conditions are simulated in an empty kiln, it will be necessary to closely watch both dry bulb and wet bulb because the dehumidification system will have a dramatic effect on both readings when the kiln is empty.

Install service gauges on the suction and discharge line valves, and thermometers on the suction and

discharge lines as close to the compressor as possible. If you have reversing fans, be sure the fans are in the "Forward" mode, the belts are tight on the blower, the blower is turning in the proper rotation, the filters are clean and check the damper operation (this is essential and instructions are given elsewhere in this manual). Be sure the air flows are all normal and note the wet/dry bulb temperatures.

A sight glass is installed in the liquid line. Do not charge to a clear sight glass. The sight glass is provided as a reference and moisture indicator only. There are only limited periods when the sight glass will clear.

Add refrigerant while monitoring suction and discharge pressure. When the actual suction line temperature drops to 80° F.-90° F, stop charging and observe pressure readings. Also note the damper position. At 120° F wet bulb they should be nearly closed or modulating from closed to slightly open. If they remain fully closed and the discharge pressure allows, add refrigerant to lower suction line temperature until they begin to modulate slightly.

At maximum operating temperature (160° F. dry bulb and 120° F. wet bulb) the following approximate readings will be noted.

The attached graphs are helpful in checking performance. It may be difficult to exactly match the lines on the graph but this provides a good check on performance. To use these graphs, select the one for the suction pressure closest to the pressure being read. Compare the actual discharge gas temperature on the chart with the temperature being read on the operating system. If the discharge gas temperature is substantially higher (12° F. - 15° F.) then the chart indicates, steps must be taken to reduce the discharge temperature.

Suction Pressure	50-60 PSIG
Discharge Pressure	375 PSIG Do not exceed 260° F.
Suction Temperature	75°F - 95°F Do not exceed 100°F
Discharge Temperature	204°-255° Do not exceed 260°F
Evaporator Damper	Modulating from closed to slightly open

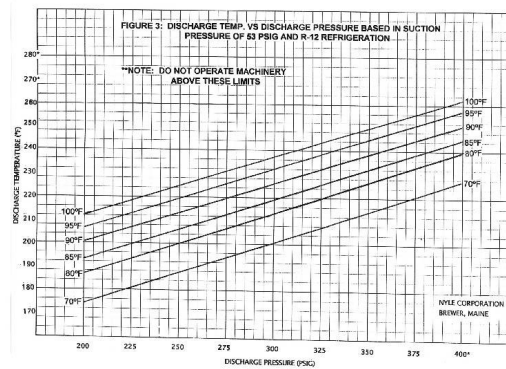
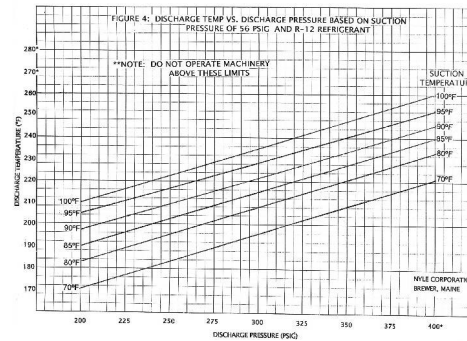
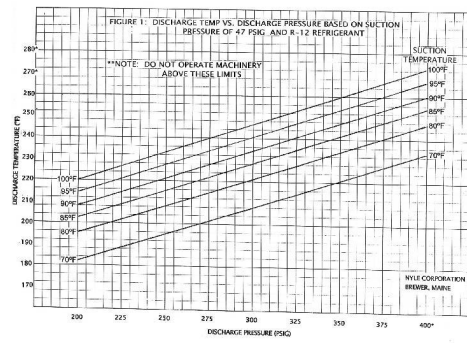

The following can affect actual discharge temperature:

1. Excessive suction gas temperature: Check the operation of the damper system. Be sure wet bulb is below 120° F, check the refrigerant charge.
2. Excessive discharge pressure, check air flow over the condenser, check blower operation (direction and belt tightness), filters, obstructions, check the refrigerant charge. Be sure the dry bulb is under 160° F.
3. A mechanical failure in the compressor, broken reed valves, bearings, etc.
4. An electrical problem with the compressor motor, such as low voltage, unbalanced voltage, loose electrical connections, motor insulation failure etc.

An increase in suction gas temperature is usually related to improper refrigerant charge, improper damper operation, air flow problems or occasionally a malfunction in the compressor or expansion valve.

Unbalanced 3-Phase Supply Voltage

A very slight voltage unbalanced will cause a major unbalance in amperage draw. Operating a motor where these conditions exist will shorten equipment life and waste energy as the end result is dramatic increase in winding temperature. The following example will show how to calculate your unbalance.

To assess the % unbalance you must find your maximum standard deviation. This number represents how much your voltage is deviating from the average voltage.

First measure the voltage for A-B, B-C & A-C as shown in the figure to the left.

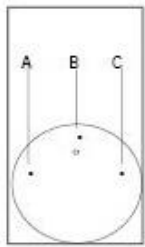

Example: AB = 200

BC = 205

AC = 216

Then find the average voltage.

Example: $200 + 205 + 216 = 621$

$621 / 3 = 207$

Find the difference between the average voltage and the measured voltages for AB, BC and AC. This is called the standard deviation. The highest number is your maximum deviation.

Note: Always put the larger number first.

Example: $AB = 207 - 200 = 7$

$BC = 207 - 205 = 2$

$AC = 216 - 207 = 9$

This voltage unbalance is accompanied by a motor temperature rise. A 10% unbalanced is equivalent to a 200% rise in temperature. Phase unbalances (which some might consider to be minimal but are quite serious) greatly shorten motor life and can cause catastrophic failure at any time.

Never operate a motor where a phase unbalanced in supply voltage is greater than 2%. If this is happening consider it a serious electrical issue and contact your local electric utility company immediately.

System Check Out Procedure

Apply power to the dehumidifier. Turn the "SYSTEM" switch to the "ON" position, the internal blower will start and the dry bulb and wet bulb controls will power up.

Dry Bulb (DB) Test Procedure:

1. Check the heat operation, press the 'UP' arrow to raise the set point value (SV) above the actual kiln chamber temperature (DB/PV), with the set point (SV) at least 5° to 10° above the actual dry bulb temperature,
2. Press the 'ENTER' key to save the new set point value. The amber light above the heat switch and the 'OUT' indicator on the controller will illuminate.
3. With an empty chamber you should notice the DB temperature increase slowly.
4. Check the vent operation, press the 'DOWN' arrow to lower the SV below the DB/PV temperature, with the SV at least 5° to 10° below the DB/PV temperature.
5. Press the 'ENTER' key to save the new set point value. The amber light above the heat switch and the 'OUT' indicator on the controller will de-energize and the amber light above the vent switch and the 'ALM1' indicator will illuminate.
6. Check to see if the vents open.
7. Raise the set point back up to the actual DB/PV temperature.
8. Press the 'ENTER' key to save the new SV. Both the heat and vent output indicators should go off. The vents should close and the heat should turn off.
9. Alarm 2 (ALM2) indicator is for the compressor alarm circuit. It will be illuminated until 163° DB. At 163° the alarm circuit will open and not allow the compressor to operate until the DB temperature cools down.

Wet Bulb (WB) Test Procedure:

1. To check the compressor operation, preheat the kiln chamber to at least 100°F DB and 80°F WB.
2. Press the 'DOWN' arrow to lower the SV below the actual wet bulb temperature.
3. Press the 'ENTER' key to save the new SV value.

The amber light above the compressor switch and the 'OUT' indicator on the controller will illuminate. After a 5 minute time delay, the compressor will start.

4. After testing the compressor, increase the SV value above the WB/PV temperature.
5. Press the 'ENTER' key to save. The amber light above the compressor switch and the 'OUT' indicator on the controller will de-energize and after a few seconds the compressor will cycle off.
6. Alarm 2 (ALM2) indicator is for the vent alarm circuit. It will be illuminated until 123°F WB. At 123°F the alarm circuit will close and energize the vents. The vents will open to cool the WB temperature in the chamber.

Appendix

Terminology

1. **DRY BULB:** The temperature as measured by a thermometer.
2. **WET BULB:** The temperature of a thermometer with a wet wick over the sensor.
3. **WET BULB DEPRESSION:** The difference between the dry bulb temperature and the wet bulb temperature.

Example: if the dry bulb is 105° F. and the wet bulb is 98° F., the depression is 105° F. - 98° F., or 7° F.

4. **RH-RELATIVE HUMIDITY:** The ratio of the amount of water in the air to what the air could hold. At 50% RH, the air has 50% as much water in it as it would hold at 100% RH. 100% is a 0° F. depression.
5. **EMC-EQUILIBRIUM MOISTURE CONTENT:** This is the average moisture content all wood will reach eventually when exposed to these conditions.

Example: At a dry bulb of 115° F. and a wet bulb of 101° F., a 14° F. depression, the EMC is 10%. This means that eventually all wood will average 10%. Wood drier than 10% will pick up water and wood that is wetter than 10% will give up water.

6. **DRI-DRYING RATE INDEX:** This is an index of relative drying rate.

Example: If a dryer is operating at 120° F. and a wet bulb depression of 12° F., and drying the load at a rate of 1.5% per day, at the DRI is 1.1. If the wood will dry at 2 times the rate (2.2/1.1=2), or 3% per day. This assumes that other conditions remain the same (airflow, stacking etc.).

Relay Activation Conditions

Relay	ON	OFF
Heater	DBT < DBT-SP - T-Hyst	DBT ≥ DBT-SP
Sprayers	WBT < WBT-SP - H-Hyst	WBT ≥ WBT-SP
Vent	DBT > DBT-SP + O-Thr	DBT ≤ DBT-SP
Compressor (when enabled)	WBT > WBT-SP + C-Hyst	WBT ≤ WBT-SP
Compressor enabling	DBT ≥ C-SP	DBT < C-SP - C-Hyst
Relays are subject to final moisture value and alarm conditions.		

DBT	Dry Bulb Temperature
WBT	Wet bulb Temperature: the difference between the dry and wet bulb temperatures is equal to the relative moisture of the air within the kiln.
DBT-SP	Dry Bulb Temperature Set Point
WBT-SP	Wet Bulb Temperature Set Point
C-SP	Compressor Temperature Set Point
T-Hyst	The value assigned to the temperature hysteresis parameter
H-Hyst	The value assigned to the humidification hysteresis parameter
O-Thr	The value assigned to the overheating threshold parameter
C-Hyst	The value assigned to the compressor hysteresis parameter

The Kiln Store

Nyle Systems likes to be there for our clients whether they have just bought a new kiln or if they have owned a Nyle kiln for years. It is because of this that we try to make replacement parts easily accessible right Online in our Kiln Store.

From the kiln store you can find many parts, equipment and accessories for both conventional kilns and DH kilns. Anything and everything you need to keep your Nyle Kiln running for years to come. We even sell parts supplies that will fit Non-Nyle kilns if you need them.

At The Kiln Store you can expect to find everything you need including:

- Accessory Kits
- Controls and Control Accessories
- Additional Heaters and Fans
- Sample Testing Supplies and Charts
- Replacement Meters, Probes and Sensors
- Replacement Belts, Filters and Parts

So when you need a part for your kiln you don't have to look any further than www.nyle.com to find exactly what you need. If you ever need assistance don't forget Nyle's star service team is always available to help you whether its finding the right replacement part or purchasing additional accessories for upgrades.

You can reach a Nyle Service Professional by:

Calling us directly at (800)777-6953 or by sending an email to service@nyle.com

Warranty

LIMITED WARRANTY: The equipment supplied by Nyle Systems is warranted to be free from defects in workmanship and materials for a period of one year from the date of the original installation under normal use and maintenance, or 15 months from the date of delivery, whichever comes first. A new or re-manufactured part will be supplied by Nyle Systems if the defective part is first returned to Nyle Systems for inspection. The replacement part assumes the unused portion of the warranty. The warranty does not include labor or other costs incurred for diagnosis, repairing or removing, installing or shipping the defective or replacement part(s). Nyle Systems makes no warranty as to the fitness of the equipment for a particular use and shall not be liable for any direct, indirect or consequential damages in conjunction with this contract and/or the use of its equipment. Buyer agrees to indemnify and save harmless Nyle Systems from any claims or demands against Nyle Systems for injuries or damages to the third parties resulting from buyer's use or ownership of the equipment. No other warranties, expressed or implied, will be honored unless in writing by an authorized officer of Nyle Systems.

Model _____

Serial Number _____

Date Purchased _____

Service Log

Issue Description	Date	Servicer

Service Log

Issue Description	Date	Servicer

nyle *Dry Kilns*

© 2021 Nyle Dry Kilns
HT- Series Manual Version 4.0